

**STK4065**

Car Stereo Use Power Amplifier (25W min, THD = 10%)

Applications

- Power amplifier for car stereos
- Home karaoke systems

Features

- High output power Maximum output power 40W or greater ($R_L = 2\Omega$)
35W typ. ($R_L = 2\Omega$, THD = 10%)
23W typ. ($R_L = 4\Omega$, THD = 10%)
- Low distortion
- Built-in protectors
 - DC short protector
 - Thermal shutdown protector (Thermal protector)
 - Overvoltage protector (Overvoltage / power supply surge protector)
 - Audio muting circuit (Fast attack time)
- Free from failure caused by load short
- Wide operating supply voltage range

Package Dimensions

unit: mm

4081

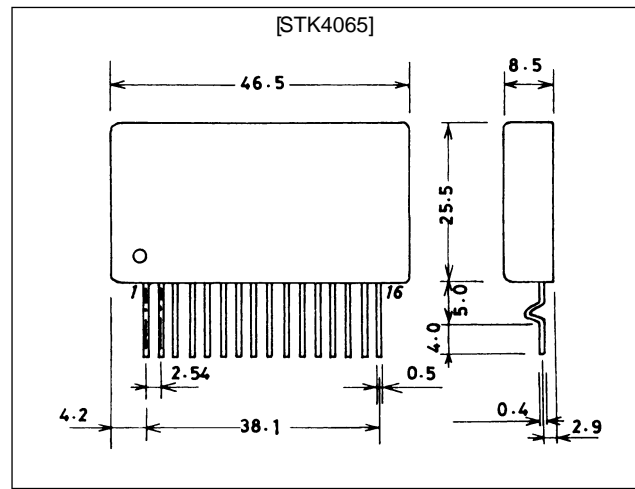

Specifications

Maximum Ratings at $T_a = 25^\circ\text{C}$

Parameter	Symbol	Conditions	Ratings	Unit
Supply voltage	$V_{CC \text{ max}(1)}$	Quiescent (circuit cutoff mode) 30s	30	V
	$V_{CC \text{ max}(2)}$	Operating ($f = 100\text{Hz}$, $V_{IN} = 1\text{Vrms}$, $t = 100\text{ms}$)	18	V
Allowable power dissipation	$P_d \text{ max}$	Infinite heat sink	100	W
Peak output power	$P_o \text{ max}$	$V_{CC} = 16\text{V}$, $R_L = 2\Omega$, $f = 1\text{kHz}$	65	W
Output current	I_o		12	A
Junction temperature	T_j		150	$^\circ\text{C}$
Thermal resistance	θ_{j-c}		1.25	$^\circ\text{C/W}$
Operating temperature	T_{opr}		-30 to +85	$^\circ\text{C}$
Storage temperature	T_{stg}		-40 to +125	$^\circ\text{C}$
Available time for load shorted	t_s	$V_{CC} = \pm 13.2\text{V}$, $R_L = 2\Omega$, $f = 50\text{Hz}$, $P_O = 25\text{W}$	2*	s

Recommended Operating Conditions at $T_a = 25^\circ\text{C}$

Parameter	Symbol	Conditions	Ratings	Unit
Recommended supply voltage	V_{CC}		13.2	V
Load resistance	R_L		2	Ω

SANYO Electric Co., Ltd. Semiconductor Business Headquarters
TOKYO OFFICE Tokyo Bldg., 1-10, 1 Chome, Ueno, Taito-ku, TOKYO, 110 JAPAN

Operating Characteristics at $T_a = 25^\circ\text{C}$, $R_L = 2\Omega$, $R_g = 600\Omega$, $V_G = 46\text{dB}$, $V_{CC} = 13.2\text{V}$

Parameter	Symbol	Conditions	min	typ	max	Unit
Quiescent current	I_{CCO}	$R_g = 10\text{k}\Omega$	–	70	140	mA
Output power	$P_{O(1)}$	THD = 10%, $f = 1\text{kHz}$	25	35	–	W
	$P_{O(2)}$	THD = 1%, $f = 1\text{kHz}$	–	25	–	W
	$P_{O(3)}$	THD = 10%, $R_L = 4\Omega$, $f = 1\text{kHz}$	20	23	–	W
Total harmonic distortion	THD(1)	$P_O = 10\text{W}$, $f = 1\text{kHz}$	–	0.06	0.1	%
	THD(2)	$P_O = 1\text{W}$, $f = 20\text{Hz}$ to 20kHz	–	–	0.3	%
Voltage gain	VG	$P_O = 1\text{W}$, $f = 1\text{kHz}$	43.8	46.0	48.2	dB
Frequency response	f_L, f_H	$P_O = 1\text{W}$, $^{+0}_{-3}\text{dB}$	–	10 to 30k	–	Hz
Input impedance	r_i	$P_O = 1\text{W}$, $f = 1\text{kHz}$	20	30	–	$\text{k}\Omega$
Output noise voltage	V_{NO}	$R_g = 10\text{k}\Omega$, without BPF	–	0.6	1.2	mVrms
Output offset voltage	ΔV_N	$R_g = 10\text{k}\Omega$	–200	0	+200	mV
Muting suppression level	ATT	$V_M = +5\text{V}$	–	∞	–	dB
Ripple rejection	SVRR	$f_R = 100\text{Hz}$, $R_g = 0\Omega$, $V_R = 0\text{dBm}$	–	–47	–	dB

* It is guaranteed that load short causes no damage for 2 seconds. In actual applications, the thermal shutdown protector provides sufficient guarantee against load short. However, refer to "Notes for Applying the STK4065", because the saturation current varies with the thermal resistance of the heat sink.

Equivalent Circuit Block Diagram

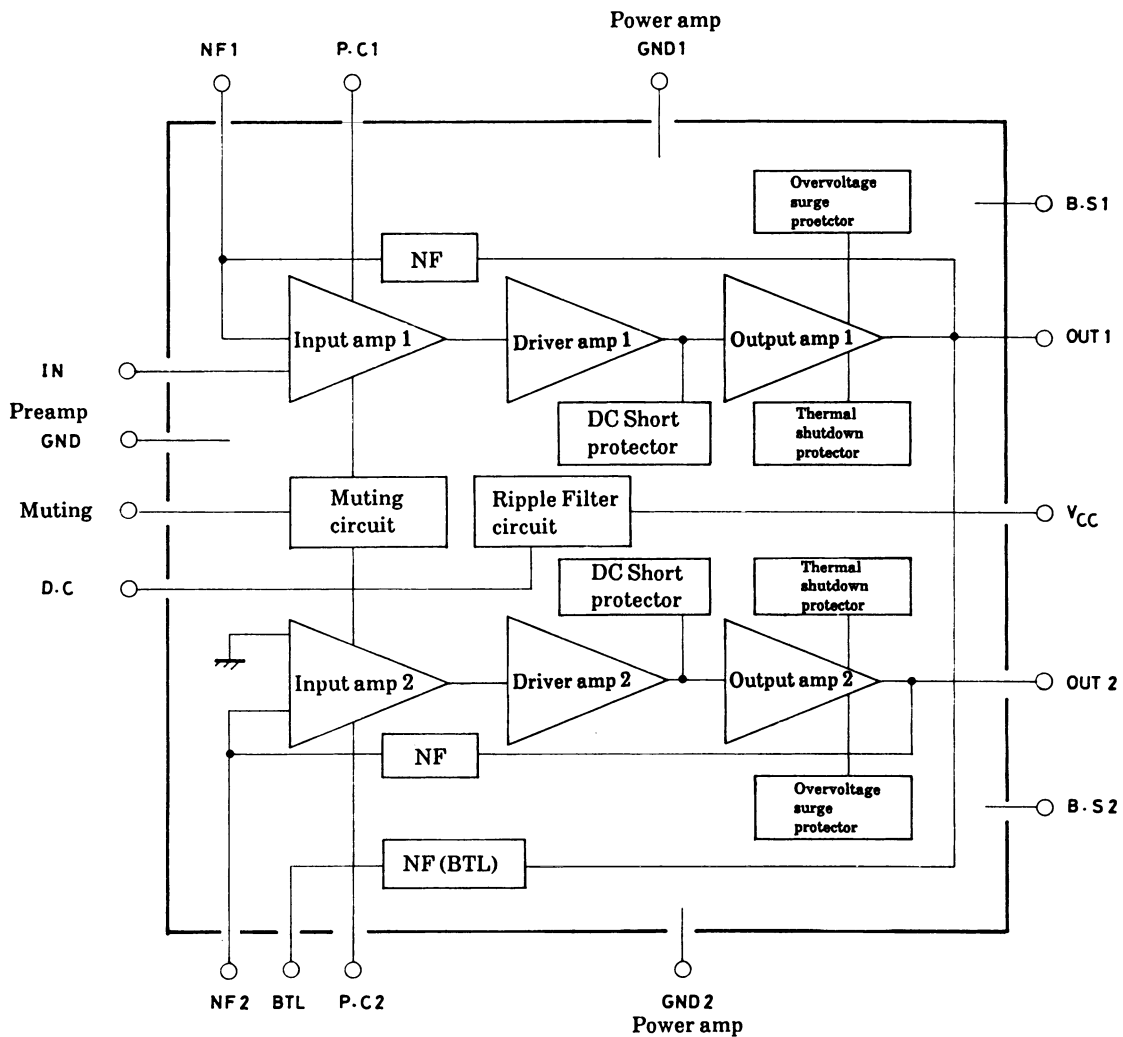

Test Circuit

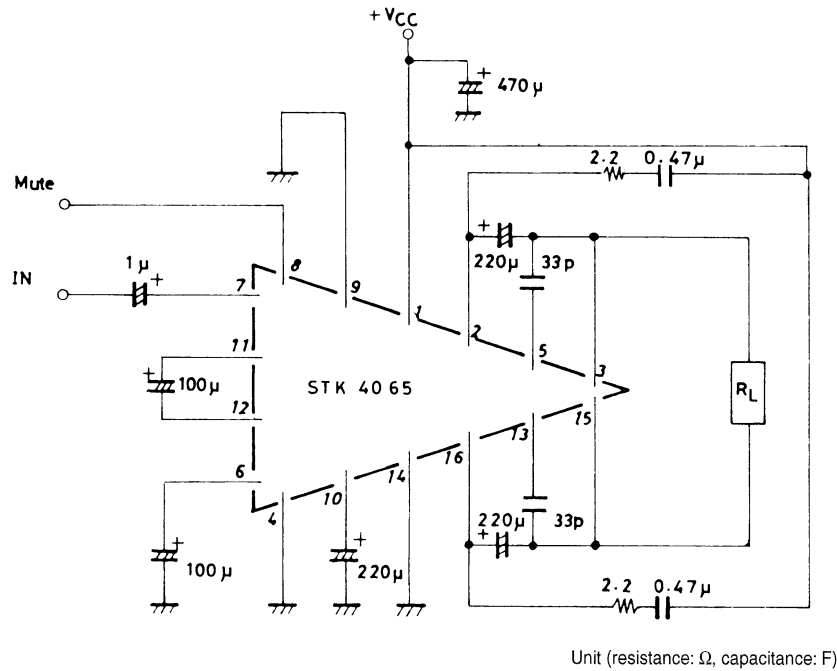

Notes for Applying the STK4065

(1) V_{CC} max

The STK4065 is designed as an amplifier for car use and its V_{CC} max at the operating mode is set to 18V. When this voltage is exceeded, the overvoltage protector will work to bring the circuit to OFF-state, delivering no output. The overvoltage protector is so designed as to work at a voltage of 18V to 28V. The protector works 100% at 28V. When designing an audio set, such as home stereo, using a transformer power supply, consider AC line regulation and be careful that 18V must not be exceeded at the quiescent mode. If 18V is exceeded, the overvoltage protector will work, generating an abnormal sound.

(2) Protectors

a) Output pin-to- V_{CC} short, output pin-to-GND short protectors

The STK4065 contains protectors against output pin-to- V_{CC} short and output pin-to-GND short.

The output pin-to- V_{CC} short protector works effectively to protect the IC when the power switch is turned ON at the output pin-to- V_{CC} short state, but does not work to protect the IC when output pin-to- V_{CC} short is forced to be provided at the normal operation mode after the power switch is turned ON.

The output pin-to- V_{CC} short protector is intended to protect the IC against damage when pin-to-pin short occurs in the assembly process.

If there is possibility that output pin-to- V_{CC} short is caused by the user, the auxiliary output pin-to- V_{CC} short protector shown on page 5 must be connected externally. The output pin-to-GND short protector works effectively to protect the IC against damage when the power switch is turned ON at the output Pin-to-GND short state and also when output pin-to-GND short is forced to be provided at the normal operation mode after the power switch is turned ON.

b) Thermal shutdown

The STK4065 contains thermal protectors.

The thermal protector detects abnormal temperature rise caused when the IC operates abnormally (load short, etc.), limits the input signal, and prevents temperature from rising, preventing the IC from breaking down in a short time. The thermal protector starts working at approximately 135°C of substrate temperature T_c and turns OFF the input signal at approximately 175°C.

In normal applications, since a heat sink is mounted on the IC, the substrate temperature does not rise up to a temperature at which the input signal is turned OFF completely, but is saturated at a certain temperature. When load short occurs with a heat sink of 4.5°C/W mounted, the substrate temperature is saturated at approximately 160°C.

T_j in this state is as high as 170°C, which obviously exceeds the maximum rating.

As mentioned above, the thermal protector is designed to prevent the IC from breaking down in a short time when abnormal temperature rise occurs, but is not intended to protect the IC from damage for a long time when abnormal temperature rise occurs.

(3) Others

a) Excessive input

When an excessive input of 1.5 V_{rms} (f = 1kHz) or greater is applied to the input pin, the input channel DC balance of the input monolithic amplifier is disturbed, the output is cut off, and DC voltage is developed on the output pins, damaging the speaker. Be careful not to permit an input of 1.5V_{rms} (f = 1kHz) or greater to be applied.

b) Parasitic oscillation

The STK4065 has 2.2Ω, 0.47μF across the V_{CC} line and the bootstrap pins for phase compensation. This makes it necessary for the power line to be extended close to the bootstrap pins for both the inverting amplifier and the non-inverting amplifier. Too long a power line may cause parasitic oscillation to occur at low temperatures. If so, connect a capacitor of approximately 0.1μF across the tip of the power line and GND to decrease AC impedance of the power line.

c) Inverse application of supply voltage

The STK4065 contains no protector against inverse application of supply voltage. If there is a possibility that inverse application of supply voltage may occur, connect the protector externally.

d) Power switch-OFF mode

Do not connect pin 1 direct to GND, otherwise the IC may be broken down.

When connecting pin 1 to GND, connect a resistor of 100Ω or greater in series with pin 1 or connect a diode across pin 10 and pin 1.

Sample Application Circuit of STK4065 Output Pin-to- V_{CC} Short Protector

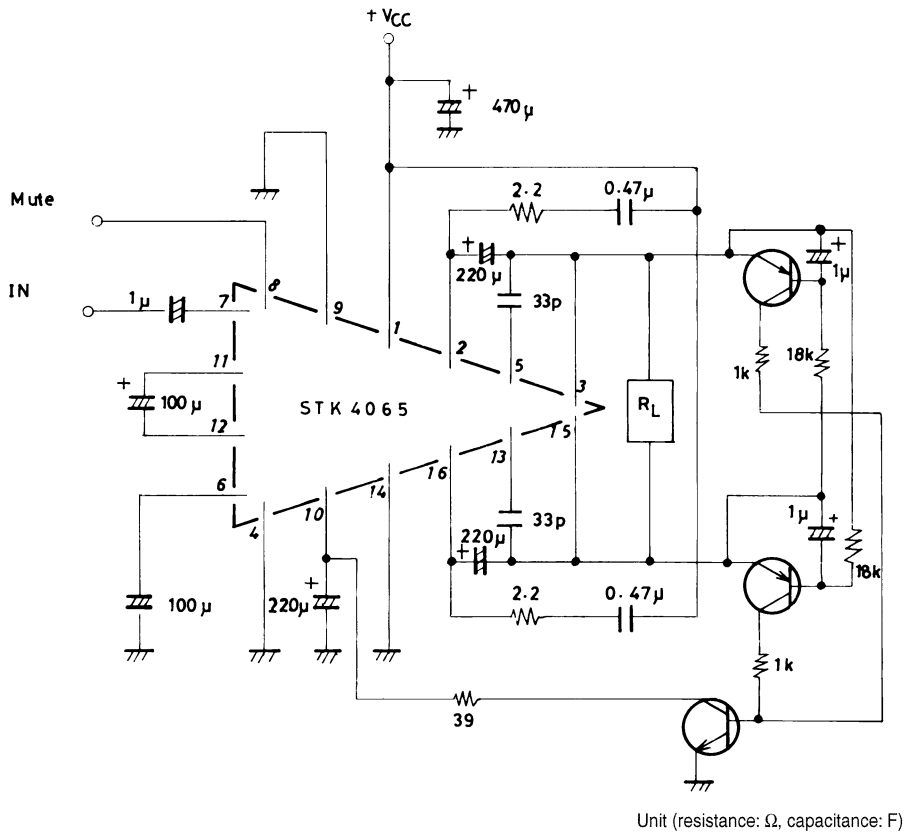

Sample Application of STK4065 $V_G = 40\text{dB}$

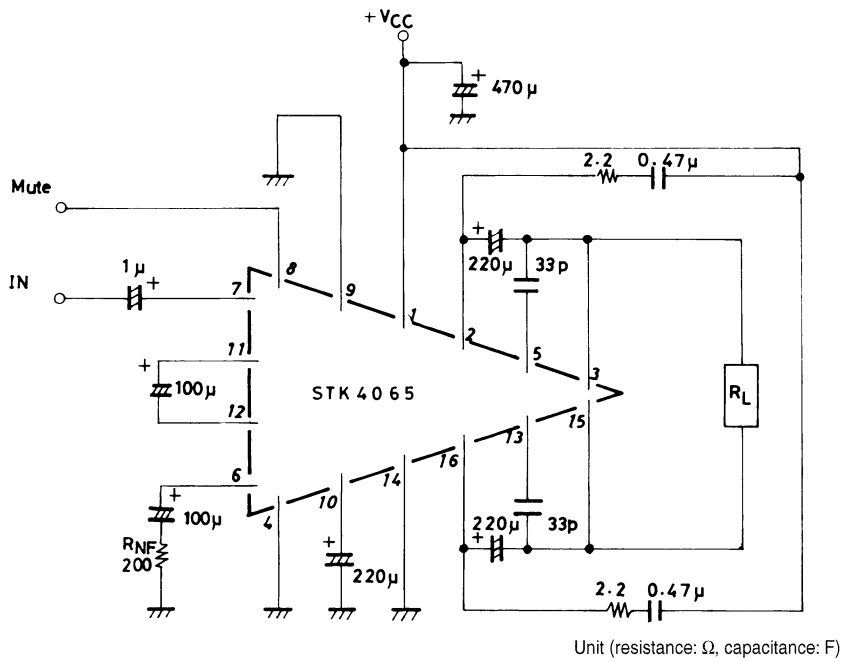

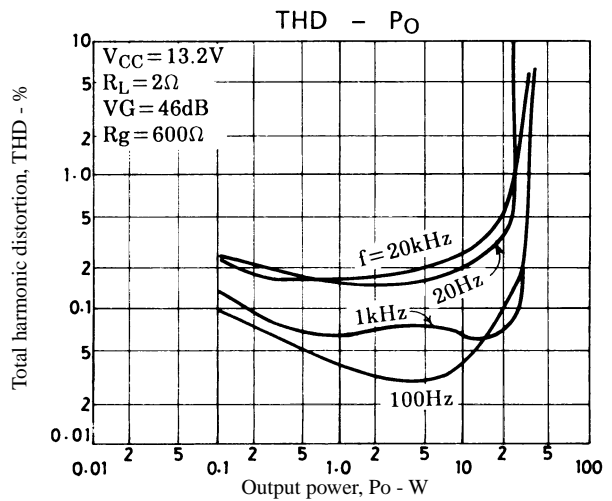
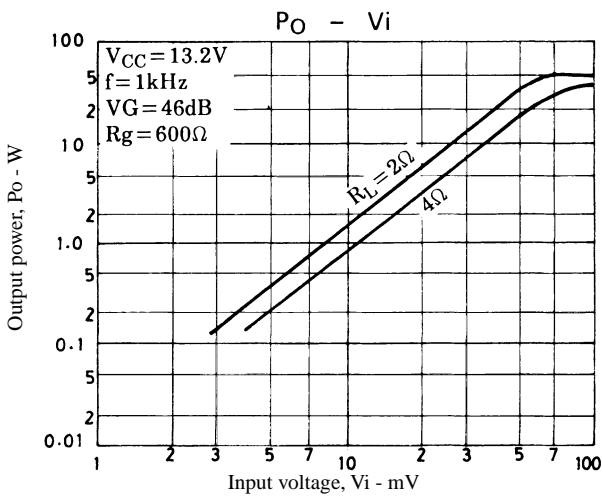
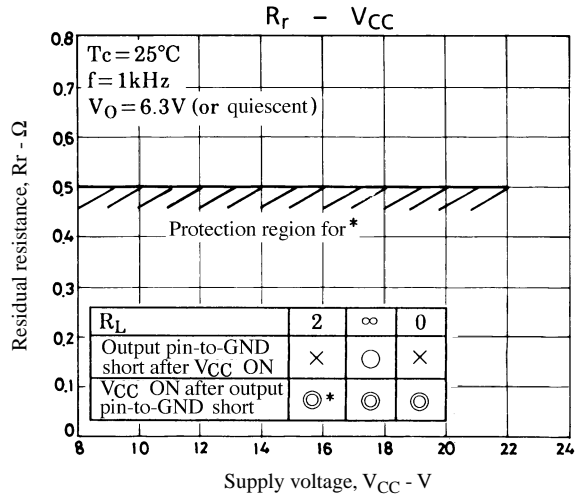
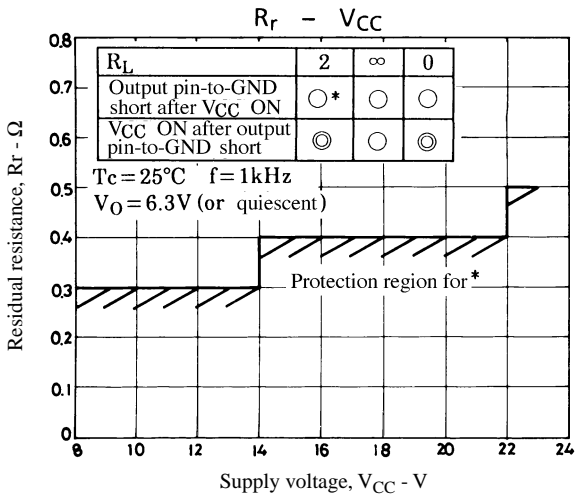
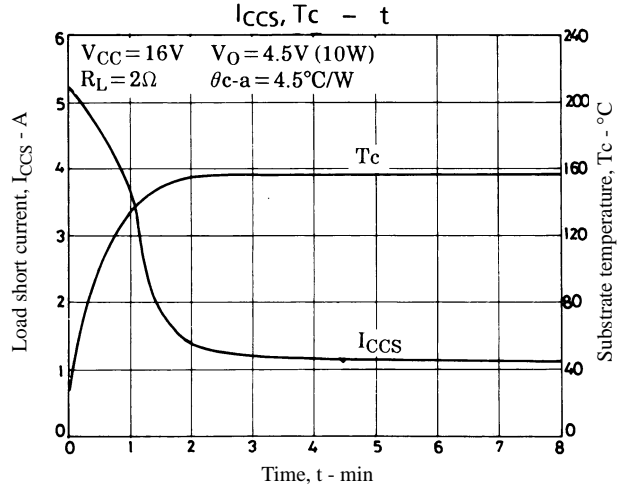
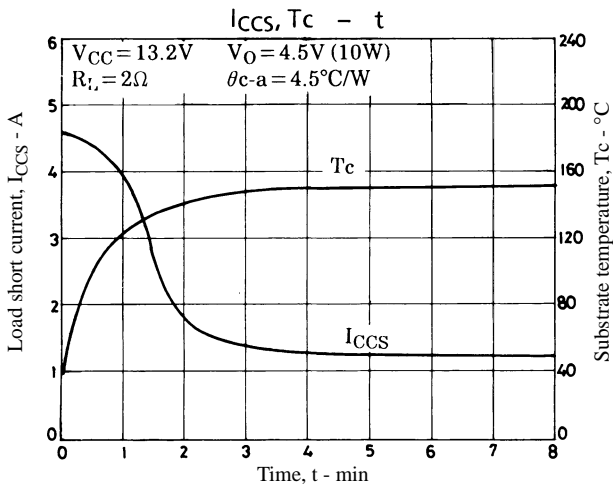

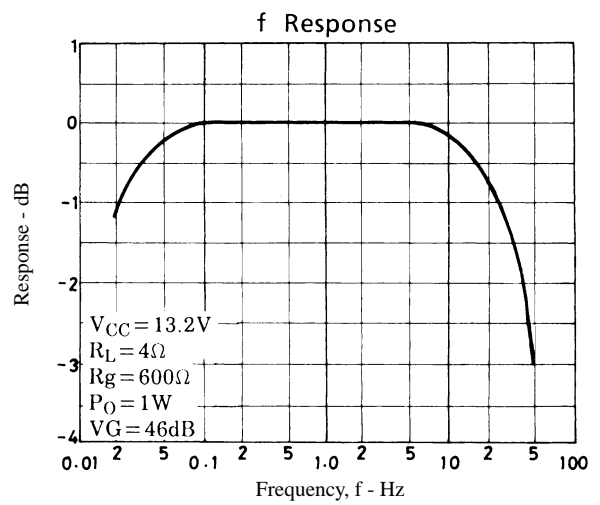
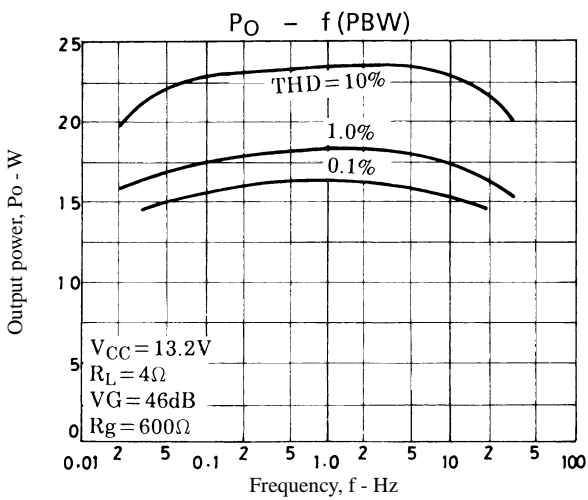
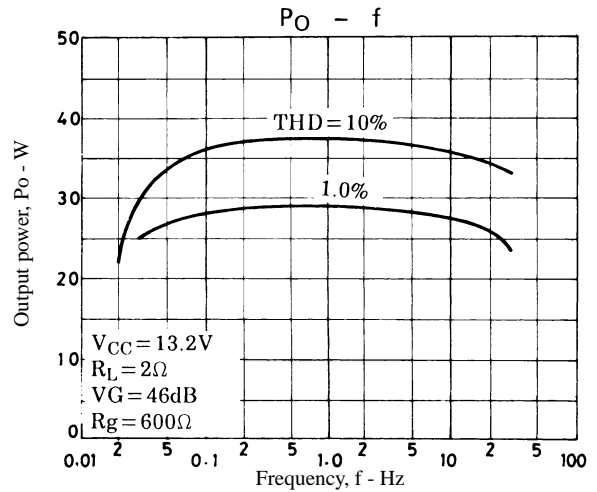
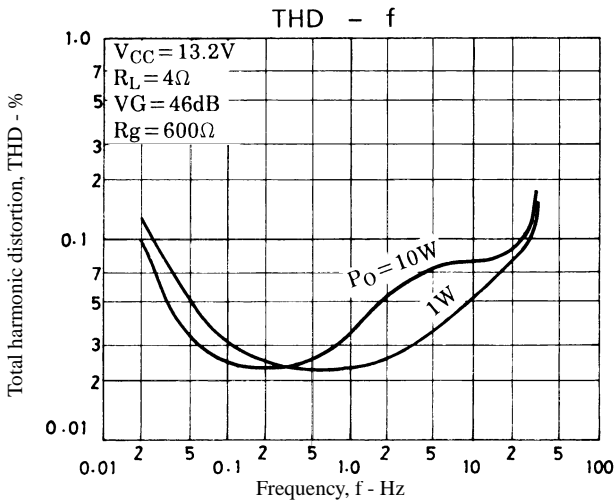
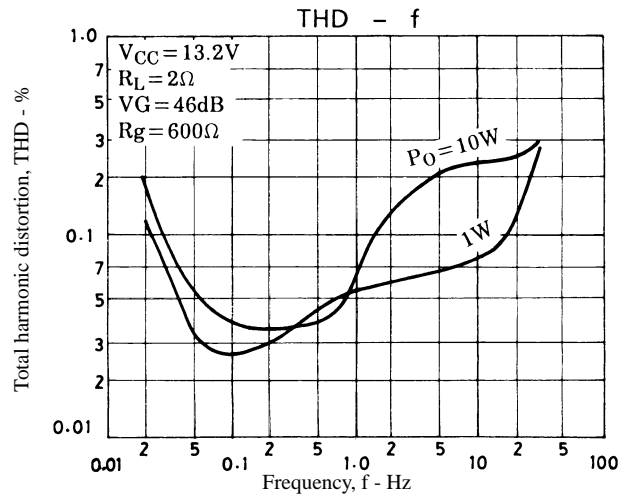
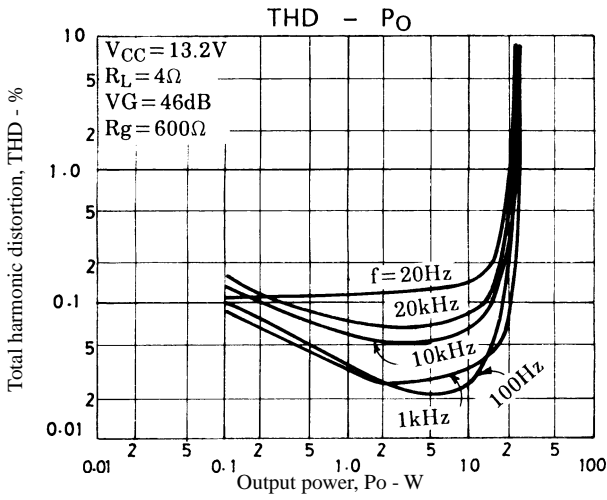

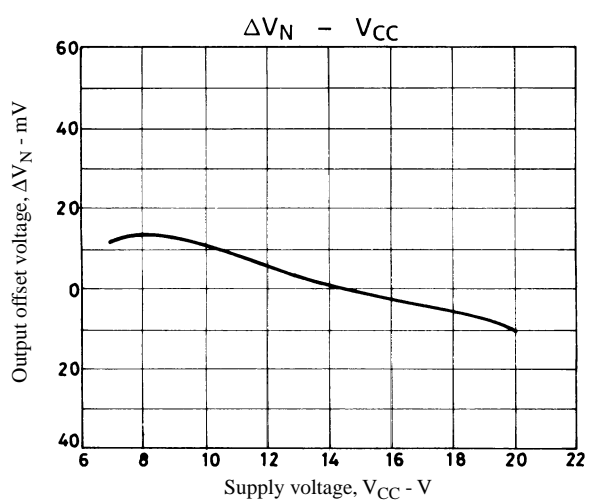
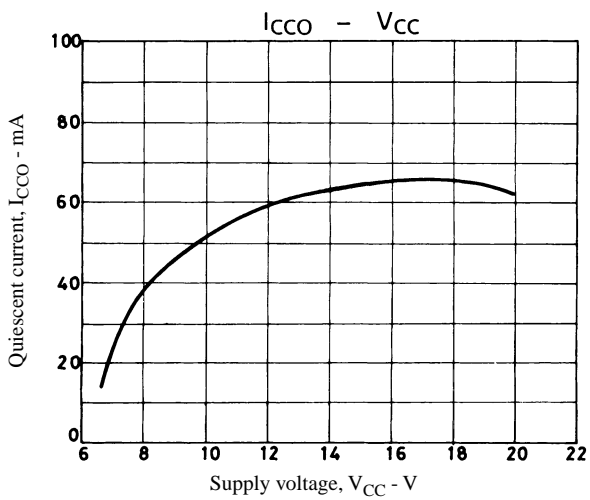
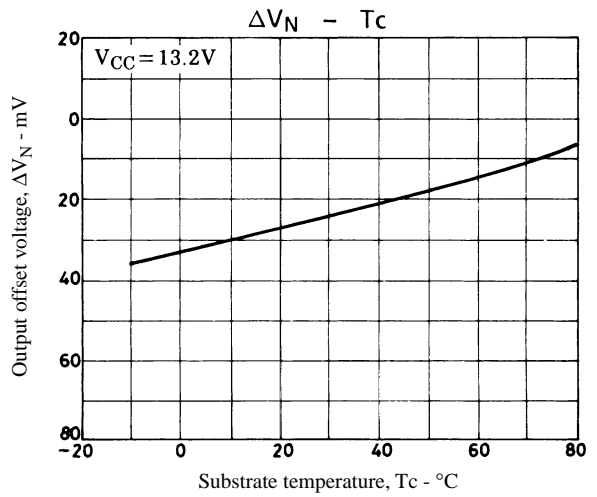
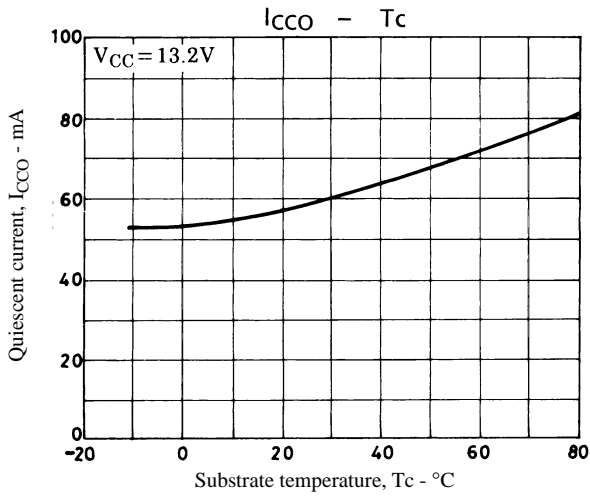
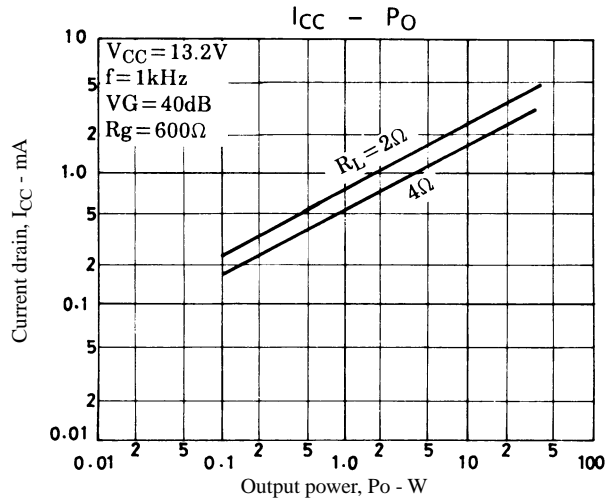
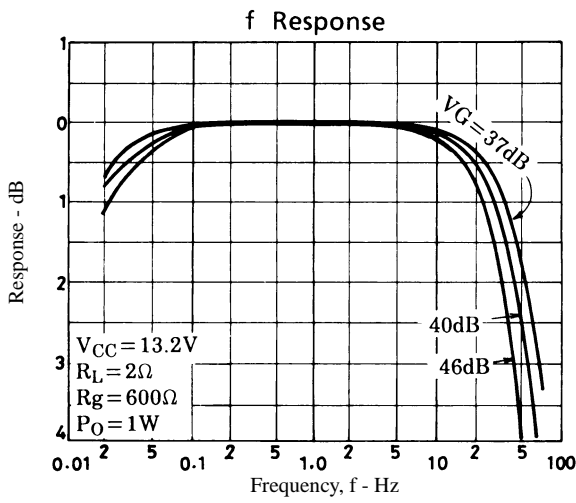

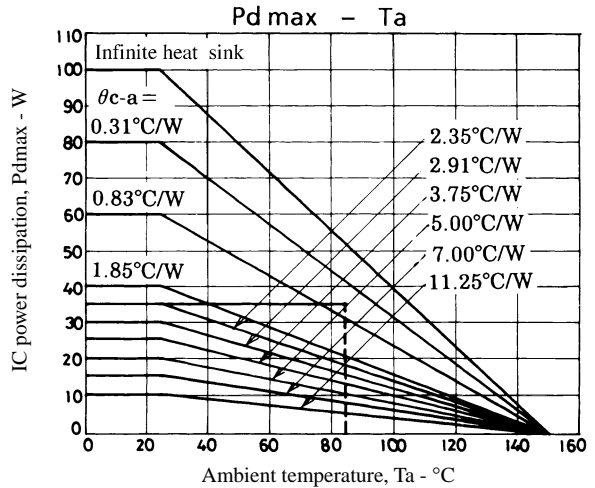
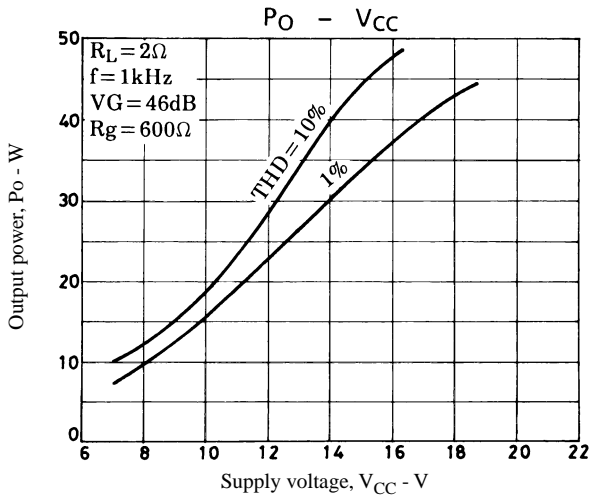
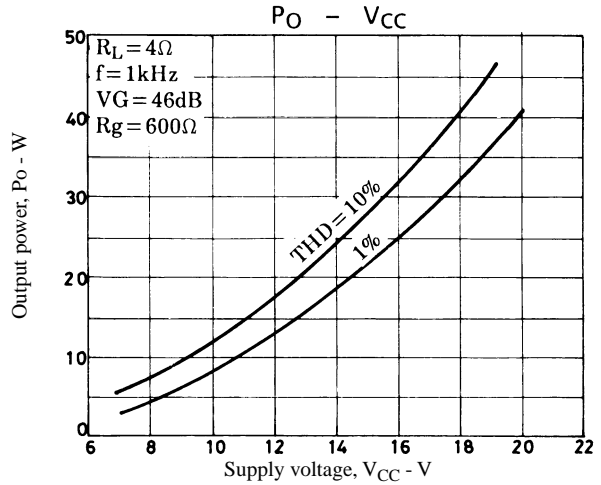
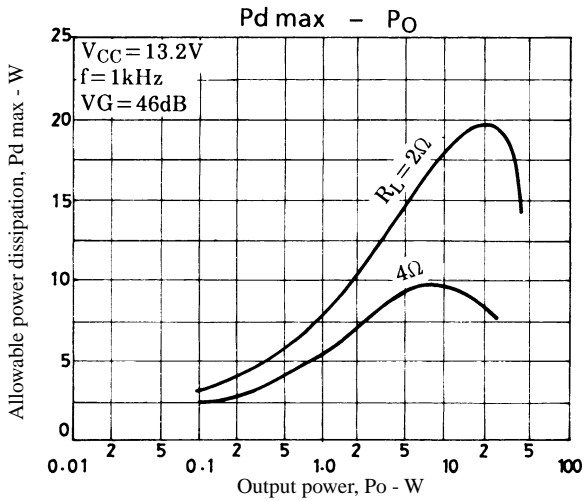

- No products described or contained herein are intended for use in surgical implants, life-support systems, aerospace equipment, nuclear power control systems, vehicles, disaster/crime-prevention equipment and the like, the failure of which may directly or indirectly cause injury, death or property loss.
- Anyone purchasing any products described or contained herein for an above-mentioned use shall:
 - ① Accept full responsibility and indemnify and defend SANYO ELECTRIC CO., LTD., its affiliates, subsidiaries and distributors and all their officers and employees, jointly and severally, against any and all claims and litigation and all damages, cost and expenses associated with such use:
 - ② Not impose any responsibility for any fault or negligence which may be cited in any such claim or litigation on SANYO ELECTRIC CO., LTD., its affiliates, subsidiaries and distributors or any of their officers and employees, jointly or severally.
- Information (including circuit diagrams and circuit parameters) herein is for example only; it is not guaranteed for volume production. SANYO believes information herein is accurate and reliable, but no guarantees are made or implied regarding its use or any infringements of intellectual property rights or other rights of third parties.

This catalog provides information as of June, 1997. Specifications and information herein are subject to change without notice.