

Fundamentals of Real-Time Spectrum Analysis

Table of Contents

| | | | |
|---|-------------|--|--------------|
| Chapter 1: Introduction and Overview | 3-8 | DPX™ Technology: a Revolutionary Tool for Signal Discovery | 25 |
| The Evolution of RF Signals | 3 | Digital Phosphor Display | 26 |
| Modern RF Measurement Challenges | 4 | The DPX Display Engine | 27 |
| A Brief Survey of Instrument Architectures | 5 | The DPX Transform Engine | 30 |
| The Swept Spectrum Analyzer | 5 | Timing and Triggers | 30 |
| Vector Signal Analyzers | 7 | Real-Time Triggering and Acquisition | 31 |
| Real-Time Spectrum Analyzers | 7 | Triggering in Systems with Digital Acquisition | 32 |
| Chapter 2: How Does the Real-Time Spectrum Analyzer Work? | 9-37 | Trigger Modes and Features | 33 |
| RF/IF Signal Conditioning | 9 | RTSA Trigger Sources | 33 |
| Input Switching and Routing Section | 10 | Constructing a Frequency Mask | 34 |
| RF and Microwave Sections | 10 | Demodulation | 35 |
| Frequency Conversion/IF Section | 11 | Amplitude, Frequency and Phase Modulation | 35 |
| Digital Signal Processing (DSP) Concepts | 12 | Digital Modulation | 36 |
| Digital Signal Processing Path in Real-Time Spectrum Analyzers | 12 | Power Measurements and Statistics | 37 |
| IF Digitizer | 13 | Chapter 3: Real-Time Spectrum Analyzer Measurements | 38-46 |
| Corrections | 13 | Real-Time Spectrum Analyzer Measurement Types | 38 |
| Digital Downconverter (DDC) | 14 | Frequency Domain Measurements | 38 |
| IQ Baseband Signals | 14 | DPX Spectrum | 39 |
| Decimation | 15 | Time Domain Measurements | 39 |
| Decimation Filtering | 15 | Modulation Domain Measurements | 42 |
| Transforming Time Domain Waveforms to the Frequency Domain | 16 | Code Domain Measurements | 44 |
| Real-Time Spectrum Analysis | 17 | Statistical Domain Measurements | 45 |
| Discovering and Capturing Transient Events | 17 | Chapter 4: Applications Using the RTSA | 47-49 |
| Relating RTSA to Swept Spectrum Analyzer | 18 | Pulse Measurements | 47 |
| RBW on the Real-Time Spectrum Analyzer | 18 | Radar | 47 |
| Windowing | 19 | RFID | 47 |
| Discrete Fourier Transforms (DFT) in the Real-Time Spectrum Analyzer | 20 | Spectrum Management/Surveillance | 48 |
| Digital Filtering | 22 | Radio Communications | 48 |
| Finite Impulse Response (FIR) Filters | 22 | Power Amplifier Testing | 49 |
| Frequency Response vs. Impulse Response | 22 | Microphonics and Phase-Hits Analysis | 49 |
| Numerical Convolution | 23 | Chapter 5: Terminology | 50-51 |
| | | Glossary | 50 |
| | | Acronym Reference | 51 |

Chapter 1: Introduction and Overview

The Evolution of RF Signals

Engineers and scientists have been looking for innovative uses for RF technology ever since the 1860s, when James Clerk Maxwell mathematically predicted the existence of electromagnetic waves capable of transporting energy across empty space. Following Heinrich Hertz's physical demonstration of "radio waves" in 1886, Nikola Tesla, Guglielmo Marconi, and others pioneered ways of manipulating these waves to enable long distance communications. At the turn of the century, the radio had become the first practical application of RF signals. Over the next three decades, several research projects were launched to investigate methods of transmitting and receiving signals to detect and locate objects at great distances. By the onset of World War II, radio detection and ranging (also known as radar) had become another prevalent RF application.

Due in large part to sustained growth in the military and communications sectors, technological innovation in RF accelerated steadily throughout the remainder of the 20th century and continues to do so today. To resist interference, avoid detection, and improve capacity, modern radar systems and commercial communications networks have become extremely complex, and both typically employ sophisticated combinations of RF techniques such as complex and adaptive modulation, bursting and frequency hopping. Designing these types of advanced RF equipment and successfully integrating them into working systems are extremely complicated tasks.

At the same time, the increasingly widespread success of cellular technology and wireless data networks combined with the advancing state of semiconductor technology and packaging has caused the cost of basic RF components to drop significantly over time. This has enabled manufacturers outside of the traditional military and communications realms to embed relatively simple RF devices into all sorts of commodity products. RF transmitters have become so pervasive that they can

be found in almost any imaginable location: consumer electronics in homes, medical devices in hospitals, industrial control systems in factories, and even tracking devices implanted underneath the skin of livestock, pets, and people.

As RF signals have become ubiquitous in the modern world, so too have problems with interference between the devices that generate them. Products such as mobile phones that operate in licensed spectrum must be designed not to transmit RF power into adjacent frequency channels and cause interference. This is especially challenging for complex multi-standard devices that switch between different modes of transmission and maintain simultaneous links to different network elements. Devices that operate in unlicensed frequency bands must be designed to function properly in the presence of interfering signals, and are legally required to transmit in short bursts at low power levels. These new digital RF technologies that involve the combination of computers and RF include wireless LANs, cellular phones, digital TV, RFID and others. These, combined with new advances in Software Defined Radio (SDR) and Cognitive Radio (CR) provide a new path forward and will fundamentally change spectrum allocation methodologies resulting in increased efficiency in the way that the RF spectrum, one of the scarcest commodities, is utilized.

To overcome these evolving challenges, it is crucial for today's engineers and scientists to be able to reliably detect and characterize RF signals that change over time, something not easily done with traditional measurement tools. To address these problems, Tektronix has designed the Real-Time Spectrum Analyzer (RTSA), an instrument that can discover elusive effects in RF signals, trigger on those effects, seamlessly capture them into memory, and analyze them in the frequency, time, modulation, statistical and code domains.

This document describes how the RTSA works and provides a basic understanding of how it can be used to solve many measurement problems associated with modern RF signals.

Modern RF Measurement Challenges

Given the challenge of characterizing the behavior of today's RF devices, it is necessary to understand how frequency, amplitude, and modulation parameters behave over short and long intervals of time. Traditional tools like Swept Spectrum Analyzers (SA) and Vector Signal Analyzers (VSA) provide snapshots of the signal in the frequency domain or the modulation domain. This is often not enough information to confidently describe the dynamic nature of modern RF signals.

Consider the following challenging measurement tasks:

- Discovery of rare, short duration events
- Seeing weak signals masked by stronger ones
- Observing signals masked by noise
- Finding and analyzing transient and dynamic signals

- Capturing burst transmissions, glitches, switching transients
- Characterizing PLL settling times, frequency drift, microphonics
- Capturing spread-spectrum and frequency-hopping signals
- Monitoring spectrum usage, detecting rogue transmissions
- Testing and diagnosing transient EMI effects
- Characterizing time-variant modulation schemes
- Isolating software and hardware interactions

Each measurement involves RF signals that change over time, often unpredictably. To effectively characterize these signals, engineers need a tool that can discover elusive events, effectively trigger on those events and isolate them into memory so that the signal behavior can be analyzed in the frequency, time, modulation, statistical, and code domains.

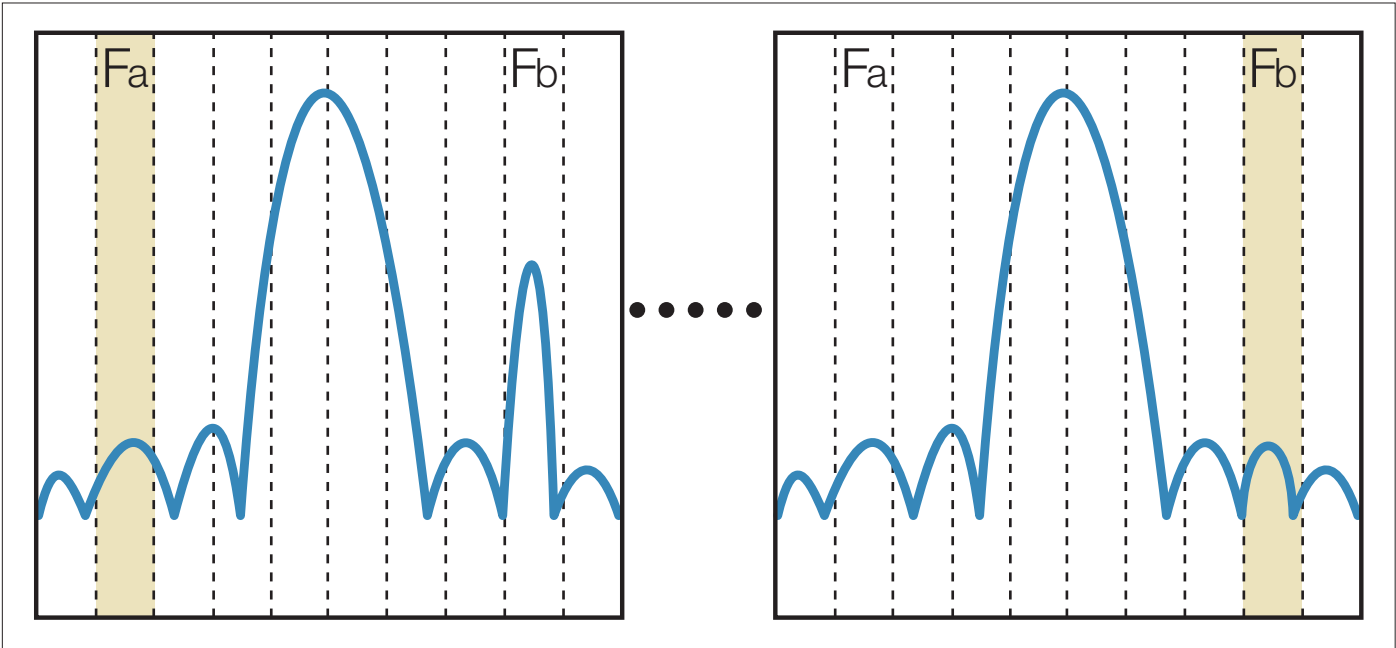

Figure 1-1. The Swept Spectrum Analyzer steps across a series of frequency segments, often missing important transient events that occur outside the current sweep band highlighted in tan segment Fb on the right.

A Brief Survey of Instrument Architectures

To learn how the RTSA works and understand the value of the measurements it provides, it is helpful to first examine two other types of traditional RF signal analyzers: the Swept Spectrum Analyzers (SA) and the Vector Signal Analyzer (VSA).

The Swept Spectrum Analyzer

The swept-tuned, superheterodyne spectrum analyzer is the traditional architecture that first enabled engineers to make frequency domain measurements several decades ago. Originally built with purely analog components, the SA has since evolved along with the applications that it serves. Current generation SAs include digital elements such as ADCs, DSPs, and microprocessors. However, the basic swept approach remains largely the same and is best suited for observing controlled, static signals. The SA makes power vs. frequency measurements by downconverting the signal of interest and sweeping it through the passband of a resolution bandwidth (RBW) filter. The RBW filter is followed by a detector that calculates the amplitude at each frequency point in the selected span. While this method can provide

high dynamic range, its disadvantage is that it can only calculate the amplitude data for one frequency point at a time. This approach is based on the assumption that the analyzer can complete at least one sweep without there being significant changes to the signal being measured. Consequently, measurements are only valid for relatively stable, unchanging input signals. If there are rapid changes in the signal, it is statistically probable that some changes will be missed. As shown in Figure 1-1, the SA is looking at frequency segment Fa while a momentary spectral event occurs at Fb (diagram on left). By the time the sweep arrives at segment Fb, the event has vanished and is not detected (diagram on right). The SA architecture does not provide a reliable way to discover the existence of this kind of transient signal, thus contributing to the long time and effort required to troubleshoot many modern RF signals. In addition to missing momentary signals, the spectrum of impulse signals such as those used in modern communications and radar may be misrepresented as well. SA architectures cannot represent the occupied spectrum of an impulse without repetitive sweeps. One also needs to pay special attention to sweep rate and resolution bandwidth.

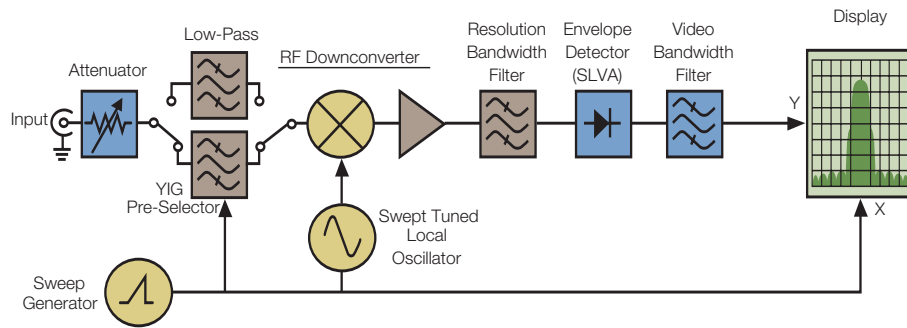

a) Swept Tuned Spectrum Analyzer (SA)

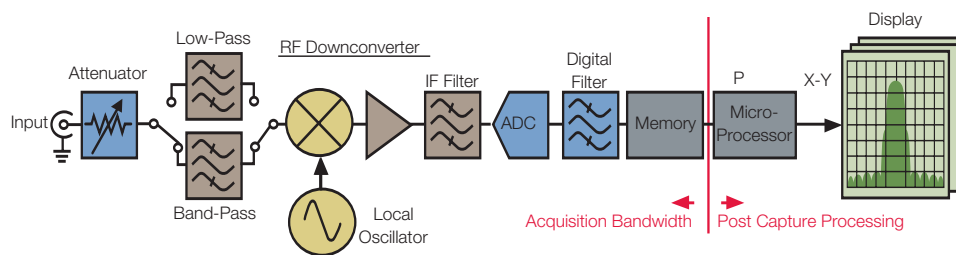

b) Vector Signal Analyzer (VSA)

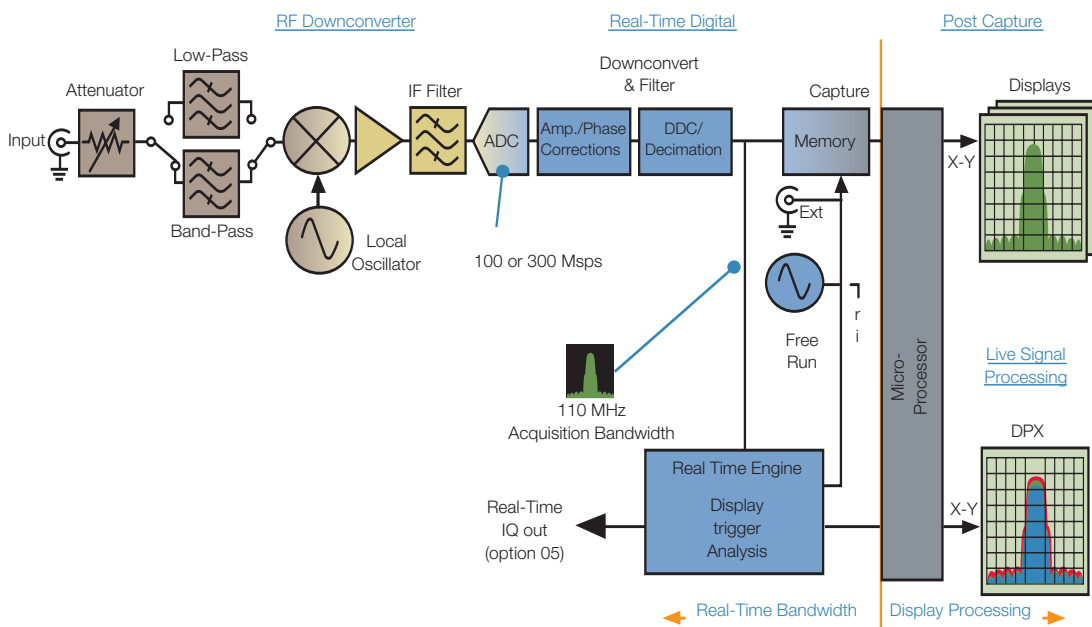

c) Real-Time Spectrum Analyzer (RSA6100 Series + Option 110)

Figures 1-2 a, b, c. Simplified Block Diagram of Swept Spectrum Analyzer (a), Vector Signal Analyzer (b), and Real-Time Spectrum Analyzer (c).

Figure 1-2a depicts a typical modern SA architecture. Even though modern SA have replaced analog functionality with digital signal processing (DSP), the fundamental architecture and its limitations remain.

Vector Signal Analyzers

Analyzing signals carrying digital modulation requires vector measurements that provide both magnitude and phase information. A simplified VSA block diagram is shown in Figure 1-2b.

A VSA digitizes all of the RF power within the passband of the instrument and puts the digitized waveform into memory. The waveform in memory contains both the magnitude and phase information which can be used by DSP for demodulation, measurements or display processing. Within the VSA, an ADC digitizes the wideband IF signal, and the downconversion, filtering, and detection are performed numerically. Transformation from time domain to frequency domain is done using FFT algorithms. The VSA measures modulation parameters such as FM deviation, Code Domain Power, and Error Vector Magnitude (EVM and constellation diagrams). It also provides other displays such as channel power, power versus time, and spectrograms.

- While the VSA has added the ability to store waveforms in memory, it is limited in its ability to analyze transient events. In the typical VSA free run mode, signals that are acquired must be stored in memory before being processed. The serial nature of this batch processing means that the instrument is effectively blind to events that occur between acquisitions. Single or infrequent events cannot be discovered reliably. Triggering on these types of rare events can be used to isolate these events in memory. Unfortunately VSAs have limited triggering capabilities. External triggering requires prior knowledge of the event in question which may not be practical. IF level triggering requires a measurable change in the total IF power and cannot isolate weak signals in the presence of larger ones or when the signals change in frequency but not amplitude. Both cases occur frequently in today's dynamic RF environment.

Real-Time Spectrum Analyzers

The term “real-time” is derived from early work on digital simulations of physical systems. A digital system simulation is said to operate in real-time if its operating speed matches that of the real system which it is simulating.

To analyze signals in real-time means that the analysis operations must be performed fast enough to accurately process all signal components in the frequency band of interest. This definition implies that we must:

- Sample the input signal fast enough to satisfy Nyquist criteria. This means that the sampling frequency must exceed twice the bandwidth of interest.
- Perform all computations continuously and fast enough such that the output of the analysis keeps up with the changes in the input signal.

Discover, Trigger, Capture, Analyze

The Real-Time Spectrum Analyzer (RTSA) architecture is designed to overcome the measurement limitations of the SA and VSA to better address the challenges associated with transient and dynamic RF signals as described in the previous sections. The RTSA performs signal analysis using real-time digital signal processing (DSP) that is done prior to memory storage as opposed to the post-acquisition processing that is common in the VSA architecture. Real time processing allows the user to discover events that are invisible to other architectures and to trigger on those events allowing their selective capture into memory. The data in memory can then be extensively analyzed in multiple domains using batch processing. The real-time DSP engine is also used to perform signal conditioning, calibration and certain types of analysis.

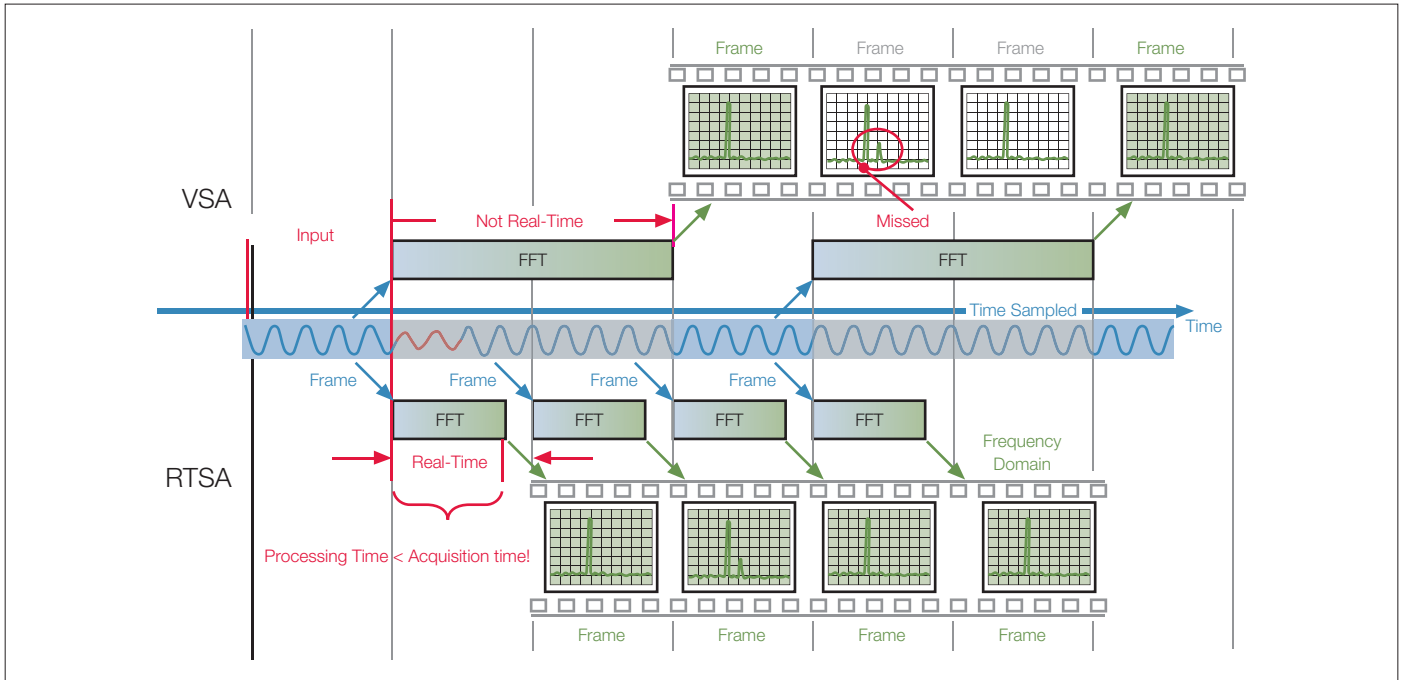

Figure 1-3. VSA processing vs. Real-Time Spectrum Analyzers real-time engine processing.

The heart of the RTSA is a real-time processing block as shown in Figure 1-2c (on page 6). Similar to the VSA, a wide capture bandwidth is digitized. Unlike the VSA, the real-time engine operates fast enough to process every sample without gaps as shown in Figure 1-3. Amplitude and phase corrections that compensate for analog IF and RF responses can be continuously applied. Not only can the data stored in memory be fully corrected, but this enables all subsequent real-time processing to operate on corrected data as well. The real-time engine enables the following features that address the needs of modern RF analysis:

- Real-time correction for imperfections in the analog signal path
- Triggering in the frequency domain with Frequency Mask Trigger (FMT)
- Triggering on user specified bandwidths with filtered power trigger

- DPX™ Live RF display allows the discovery of events missed by swept SAs and VSAs
- Real-time demodulation allowing the user to “listen” to a particular signal within a busy band
- Digital IQ streaming of digitized data allows the uninterrupted output of the signal for external storage and processing

The real-time engine not only enables signal discovery and trigger, but it also performs many of the repetitive signal processing tasks, freeing up valuable software-based resources. Like the VSA, the RTSA offers post-acquisition analysis using DSP. It can perform measurements in multiple time-correlated domains that can be displayed simultaneously.

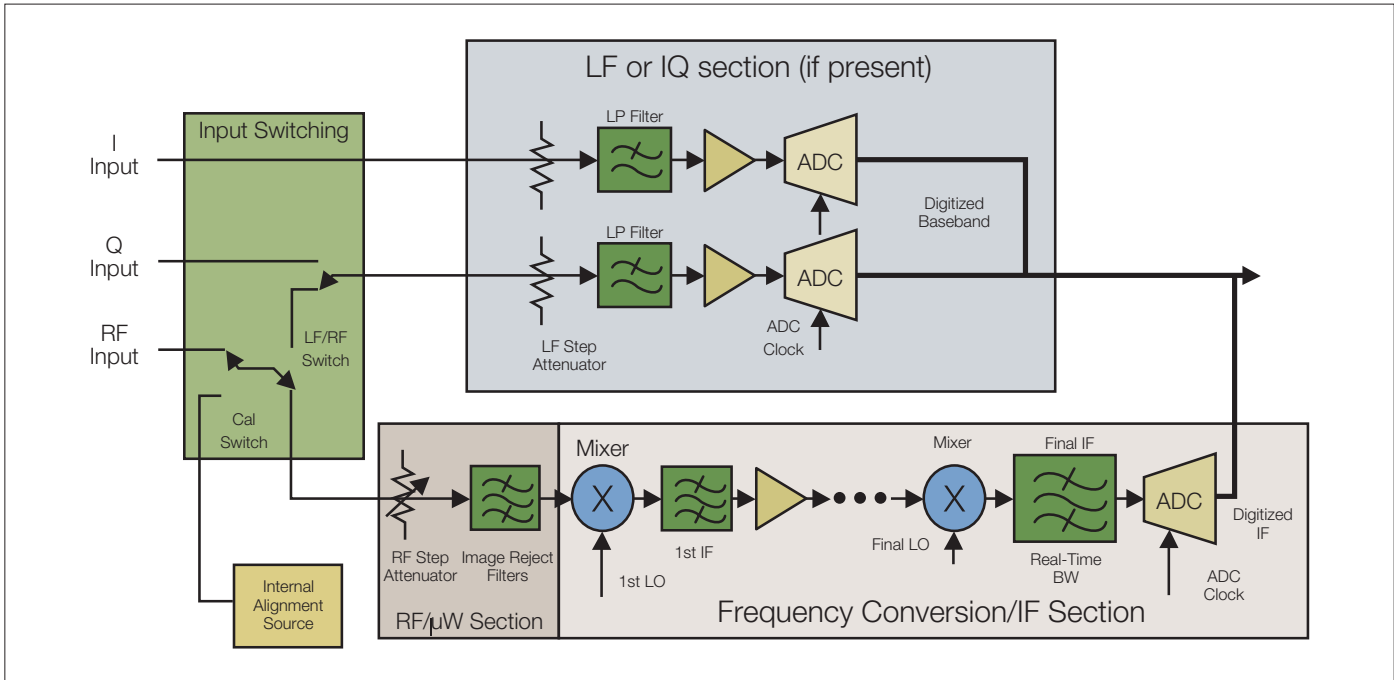

Figure 2-1. Real-Time Spectrum Analyzer RF/IF block diagram.

Chapter 2: How Does the Real-Time Spectrum Analyzer Work?

This chapter contains several architectural diagrams of the main acquisition and analysis blocks of the Tektronix Real-Time Spectrum Analyzer (RTSA). Some ancillary functions have been omitted to clarify the discussion.

Modern RTSAs can acquire a passband, or span, anywhere within the input frequency range of the analyzer. At the heart of this capability is an RF downconverter followed by a wide-band intermediate frequency (IF) section. An ADC digitizes the IF signal and the system carries out all further steps digitally. DSP algorithms perform all signal conditioning and analysis functions.

Several key characteristics distinguish a successful real-time architecture:

- RF signal conditioning that provides a wide-bandwidth IF path and high dynamic range.
- An ADC system capable of digitizing the entire real-time BW with sufficient fidelity and dynamic range to support the desired measurements.
- A real-time digital signal processing (DSP) engine enables processing with no gaps.
- Sufficient capture memory and DSP power to enable continuous real-time acquisition over the desired time measurement period.

- An integrated signal analysis system that provides multiple analysis views of the signal under test, all correlated in time.

RF/IF Signal Conditioning

Figure 2-1 shows a simplified RTSA RF/IF block diagram. Signals with frequency content anywhere in the frequency range of the RTSAs are applied to the input connector. Once signals enter the instrument, they are routed and conditioned in accordance with the needs of the analysis selected by the user. Variable attenuation and gain is applied. Tuning is achieved using multi-stage frequency conversion and a combination of tunable and fixed local oscillators (LO). Analog filtering is done at the various IF frequencies. The last IF is digitized with an A/D converter. All further processing is performed using DSP techniques. Some RTSA models have optional baseband modes where the input signal is digitized directly, without any frequency conversions. The DSP for baseband signals follows a similar approach as is used with RF signals.

Input Switching and Routing Section

The input switching and routing section distributes the input waveforms to the various signal paths within the instrument. Some RTSA models include a separate DC coupled baseband path for increased dynamic range and accuracy when analyzing low frequency signals as well as DC coupled IQ baseband paths. RTSAs also include internal alignment sources. These alignment sources, which produce signals with properties that are specifically tailored for the RTSA (PRBS, calibrated sinusoids, modulation references, etc.) are used in self-alignment procedures that correct for temperature variations in system parameters such as:

- Gain
- Amplitude flatness across the acquisition bandwidth
- Phase linearity across the acquisition bandwidth
- Time alignment
- Trigger delay calibration

The self-alignment processes, when combined with calibrations using external equipment performed at the factory or the service center, are at the heart of all critical measurement specifications of RTSAs.

RF and Microwave Sections

The RF/Microwave section contains the broadband circuitry that conditions the input signals so that they have the proper level and frequency content for optimal downstream processing.

Step Attenuator

The step attenuator is a device composed of resistive attenuator pads and RF/ μ W switches that decreases the level of broadband signals by a programmed amount. The step attenuator performs two functions:

1. It reduces the level of RF and microwave signals at the input to a level that is optimum for processing. The step attenuator also protects the input from damage due to very high level signals by absorbing excessive RF power.
2. It presents a broadband impedance match over the entire frequency range of the instrument. This impedance match is crucial in maintaining accuracy in measuring RF signals. For this reason, most instrument specifications are stated for the condition of 10 dB or more input attenuation.

Step attenuators used by RTSAs vary by model in their design. They typically can be programmed to attenuate from 0 to greater than 50 dB in steps of 5 or 10 dB.

Image Reject Filter

RTSAs provide image-free frequency conversion from the RF and microwave signals at their input to the final IF. This is accomplished by placing a variety of filters in front of the first mixer. The various RTSA models use multi-stage mixing schemes incorporating broadband filters that allow image-free conversion of the entire acquisition bandwidth with repeatable, specified amplitude flatness and phase linearity.

Preamplifier

Some RTSA models include options for a selectable preamplifier that adds gain to the signal path prior to the image reject filter. This option improves the noise figure of the RTSAs and is useful for analyzing very weak signals. Adding gain at the input, of course, limits the largest signal that can be analyzed. Switching this amplifier out of the signal path returns the analyzer's range to normal.

Frequency Conversion/IF Section

All RTSA models can analyze a broad band of frequencies centered anywhere in the analyzer's frequency range. This is done by converting the band of interest to a fixed IF where it is filtered, amplified and scaled. This IF signal is then digitized. Real-time and batch processing are then used to perform multi-domain analysis on the signals of interest.

Multi-Stage Frequency Conversion

The goal of the frequency conversion section is to faithfully convert signals in the desired band of frequencies to an IF suitable for analog-to-digital conversion. Tuning is accomplished by selecting the frequencies of local oscillators (LO) in a multiple conversion superheterodyne architecture as shown in Figure 2-1 (on page 9). Each frequency conversion stage contains a mixer (analog multiplier) followed by IF filtering and amplification. The choices of IF frequencies, filter shapes, gains, and levels differ depending on RTSA model and indeed are changed within each model as a function of instrument settings in order to optimize performance in several areas as listed below:

- Spurious responses due to mixer and filter imperfections
- Dynamic range (smallest and largest signals that can be viewed simultaneously without errors)
- Amplitude flatness across the real-time bandwidth
- Phase linearity across the real-time bandwidth
- Delay match between the signal and trigger paths

Internal Alignment Sources

The performance achieved in RTSAs for some characteristics mentioned in the previous bulleted list far exceeds what is practical with analog components. Filter responses, delays and gains vary over temperature and can be different for individual instruments. RTSAs performance is achieved by actually measuring gains, filter shapes and delays and using DSP to compensate for the measured performance. The frequency response and gain variations of the wideband RF components is measured at the factory with calibrated equipment, traceable to National Metrology Institutes such as NIST, NPL, PTB. This equipment is also used to calibrate the internal alignment sources which in turn provide signals that adjust for the signal path conditions at the time and place where the RTSA is used. RTSAs use two kinds of internal signals:

- A highly accurate, temperature stable sinusoidal signal is used to set the signal path gain at a reference frequency, typically 100 MHz. This signal is the internal RF level reference. It sets the accuracy in measuring RF power at the center of the acquisition bandwidth.
- A calibrated broadband signal is used to measure the amplitude and phase response across the real-time acquisition BW. This signal is the internal channel response reference. It provides the information that allows DSP to compensate for the amplitude, phase and delay variations across the acquisition bandwidth.

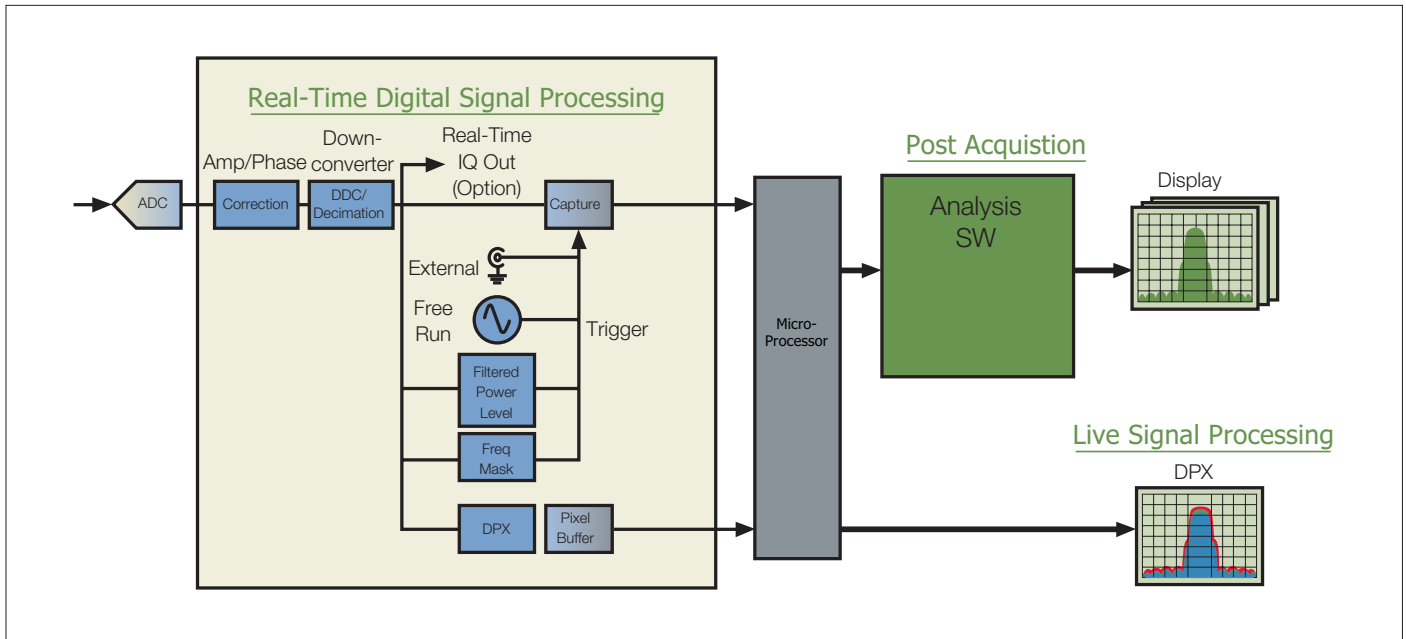

Figure 2-2. Real-Time Spectrum Analyzer Digital Signal Processing Block Diagram.

Digital Signal Processing (DSP) Concepts

This section contains several architectural diagrams of the main acquisition and analysis blocks typical of Tektronix RTSAs. Specific implementations vary by model number and by specific measurement function. Some ancillary functions have been omitted to clarify the discussion.

Digital Signal Processing Path in Real-Time Spectrum Analyzers

Tektronix RTSAs use a combination of analog and digital signal processing (DSP) to convert RF signals into calibrated, time-correlated multi-domain measurements. This section deals with the digital portion of the RTSAs signal processing flow.

Figure 2-2 illustrates the major digital signal processing blocks used in the Tektronix RTSAs. A band of frequencies from the

RF input is converted to an analog IF signal that is bandpass filtered and digitized. Corrections are applied to the sampled data correcting for amplitude flatness, phase linearity and other imperfections of the signal path. Some corrections are applied in real-time, others are applied further downstream in the signal processing path.

A digital downconversion and decimation process converts the A/D samples into streams of in-phase (I) and quadrature (Q) baseband signals as shown in Figure 2-3 (on the next page). This IQ representation of the desired signal is the basic form for representing signals in all RTSAs. DSP is then used to perform all further signal conditioning and measurements. Both real-time DSP and batch mode DSP are used in RTSAs.

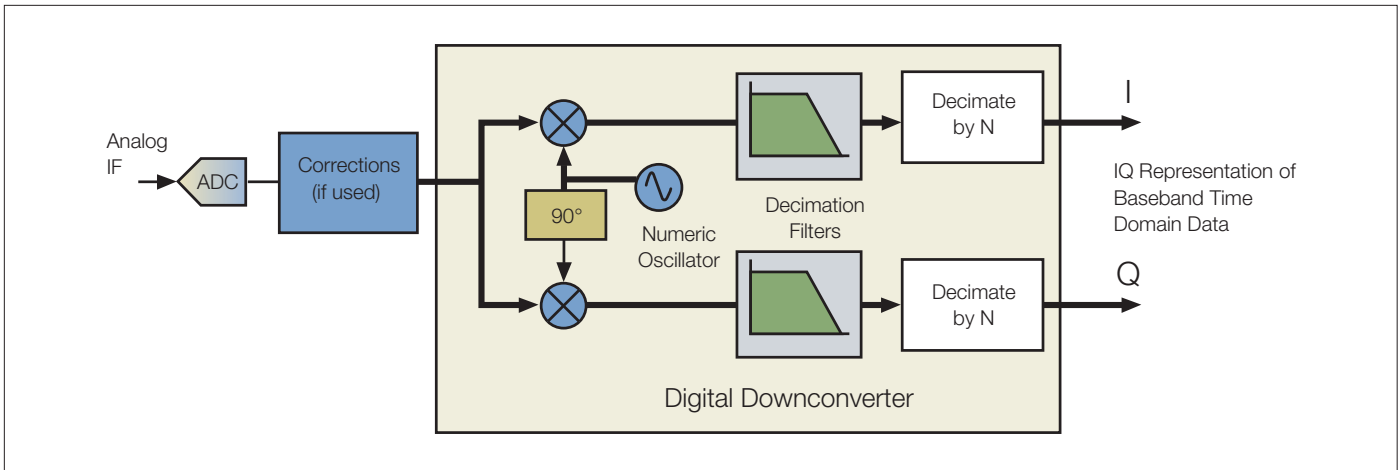

Figure 2-3. IF to IQ conversion in a Real-Time Spectrum Analyzer.

IF Digitizer

Tektronix RTSAs typically digitize a band of frequencies centered on an intermediate frequency (IF). This band of frequencies is the widest frequency for which real-time analysis can be performed. Digitizing at a high IF rather than at DC or baseband has several signal processing advantages (spurious performance, DC rejection, dynamic range, etc.). The sampling rate is chosen so that the desired IF bandwidth fits within a Nyquist zone as shown in Figure 2-4 (on the next page). The sampling rate must be at least twice the IF bandwidth. Sampling without aliasing is possible if the entire if bandwidth fits between zero and one-half the sampling frequency, one-half and one, three-halves and twice, etc. The practical implementations of IF filters require typical sampling rates at least two-and-a-half times the IF bandwidth.

Corrections

The RTSA specifications for amplitude flatness, phase linearity and level accuracy far exceed what is practical with the components that comprise the analog RF and IF signal conditioning portions of the signal path. Tektronix RTSAs use a combination of factory calibration and internal self-alignment to compensate for analog component variations (temperature, tolerance, aging, etc.) in the signal path.

Factory Calibration

The RF frequency response of the RTSA over its range of input frequencies is measured at the factory. The RF behavior at the center of an acquisition bandwidth is predictable over temperature and does not vary appreciably as the instrument ages. Once measured in the factory, the RF response is stored in a correction table that resides in non-volatile memory.

Internal Alignment

The response across the acquisition bandwidth is affected by the combination of mixers, filters and amplifiers that comprise the IF processing path. These components can have fine-grain amplitude and phase ripple over the wide bandwidths acquired by RTSAs. An internal alignment process measures the amplitude and phase response as a function of offset from the center frequency. The alignment is done at the time and place where the instrument is in use and can be triggered either manually or as a function of temperature. This response is stored in memory.

Correction Process

The RTSA correction process combines the RF response measured at the factory with the IF response measured during internal alignments to generate FIR coefficients for a set of correction filters that compensate for amplitude flatness and phase response of the entire path between the input connector and the ADC. These correction filters are implemented either in real-time digital hardware or in software-based DSP depending on RTSAs model and are applied to the digitized IQ stream.

Digital Downconverter (DDC)

A common and computationally efficient way to represent bandpass signals is to use the complex baseband representation of the waveform.

RTSAs use the Cartesian complex form, representing the time sampled data as I (in-phase) and Q (quadrature) baseband components of the signal. This is achieved using a digital downconverter (DDC) as shown in Figure 2-3.

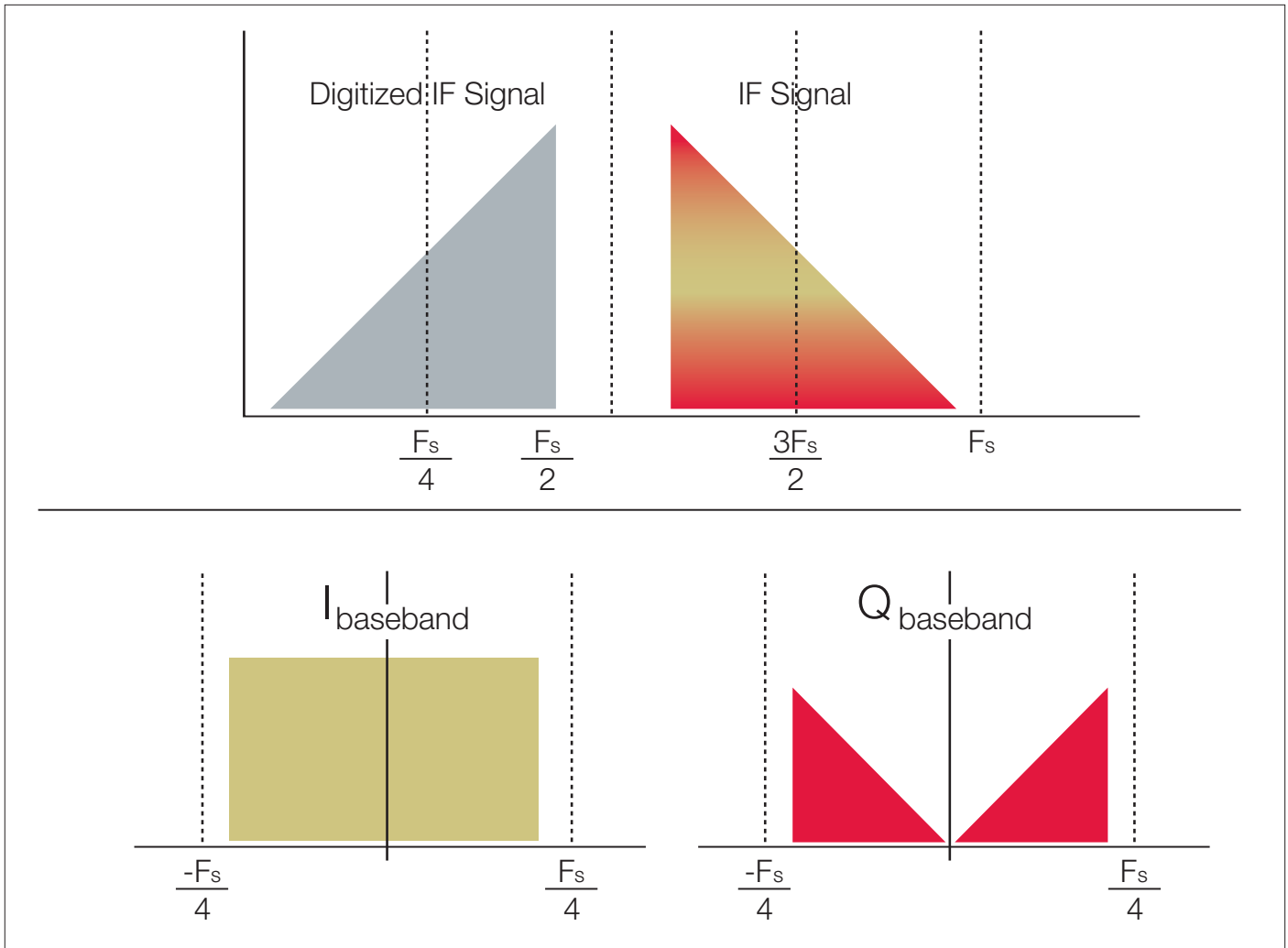

Figure 2-4. Passband information is maintained in I and Q even at half the sample rate.

In general, a DDC contains a numeric oscillator that generates a sine and a cosine at the center frequency of the band of interest. The sine and cosine are numerically multiplied with the digitized IF signal; generating streams of I and Q baseband samples that contain all of the information present in the original IF. DDCs are used not only to convert digitized IF signals to baseband but also in fine frequency tuning in RTSAs.

IQ Baseband Signals

Figure 2-4 illustrates the process of taking a frequency band and converting it to baseband using digital downconversion. The original IF signal in this case is contained in the space

between one half of the sampling frequency and the sampling frequency. Sampling produces an image of this signal between zero and one-half the sampling frequency. The signal is then multiplied with coherent sine and cosine signals at the center of the passband of interest and followed by an anti-aliasing filter, generating I and Q baseband signals. The baseband signals are real-valued and symmetric about the origin. The same information is contained in the positive and negative frequencies. All of the modulation contained in the original passband is also contained in these two signals. The minimum required sampling frequency for each is now half of the original. It is then possible to decimate by two.

Decimation

The Nyquist theorem states that for baseband signals one need only sample at a rate equal to twice the highest frequency of interest. For bandpass signals one needs to sample at a rate at least twice the bandwidth. The sample rate can be reduced when the needed bandwidth is less than the maximum. Sample rate reduction, or decimation, can be used to balance bandwidth, processing time, record length and memory usage. The Tektronix RSA6100 Series, for example, uses a 100 MS/s sampling rate at the A/D converter to digitize a 40 MHz acquisition bandwidth, or span. The I and Q records that result after DDC, filtering and decimation for this 40 MHz acquisition bandwidth are at an effective sampling rate of half the original, that is, 50 MS/s. The total number of samples is unchanged: we are left with two sets of samples, each at an effective rate of 50 MS/s instead of a single set at 100 MS/s. Further decimation is made for narrower acquisition bandwidths or spans, resulting in

longer time records for an equivalent number of samples. The disadvantage of the lower effective sampling rate is a reduced time resolution. The advantages of the lower effective sampling rate are fewer computations for analysis and less memory usage for a given time record.

Decimation Filtering

The Nyquist requirements must also be observed when decimating. If the data rate is reduced by a factor of two, then the bandwidth of the digital signal also must be reduced by a factor of two. This must be done with a digital filter prior to the reduction in sample rate to prevent aliasing. Many levels of decimation are used in Tektronix RTSAs. Each level contains a digital filter followed by a reduction in the number of samples. An additional advantage of decimation and filtering is a reduction in noise with the reduced bandwidth. This reduction in noise is often called processing gain.

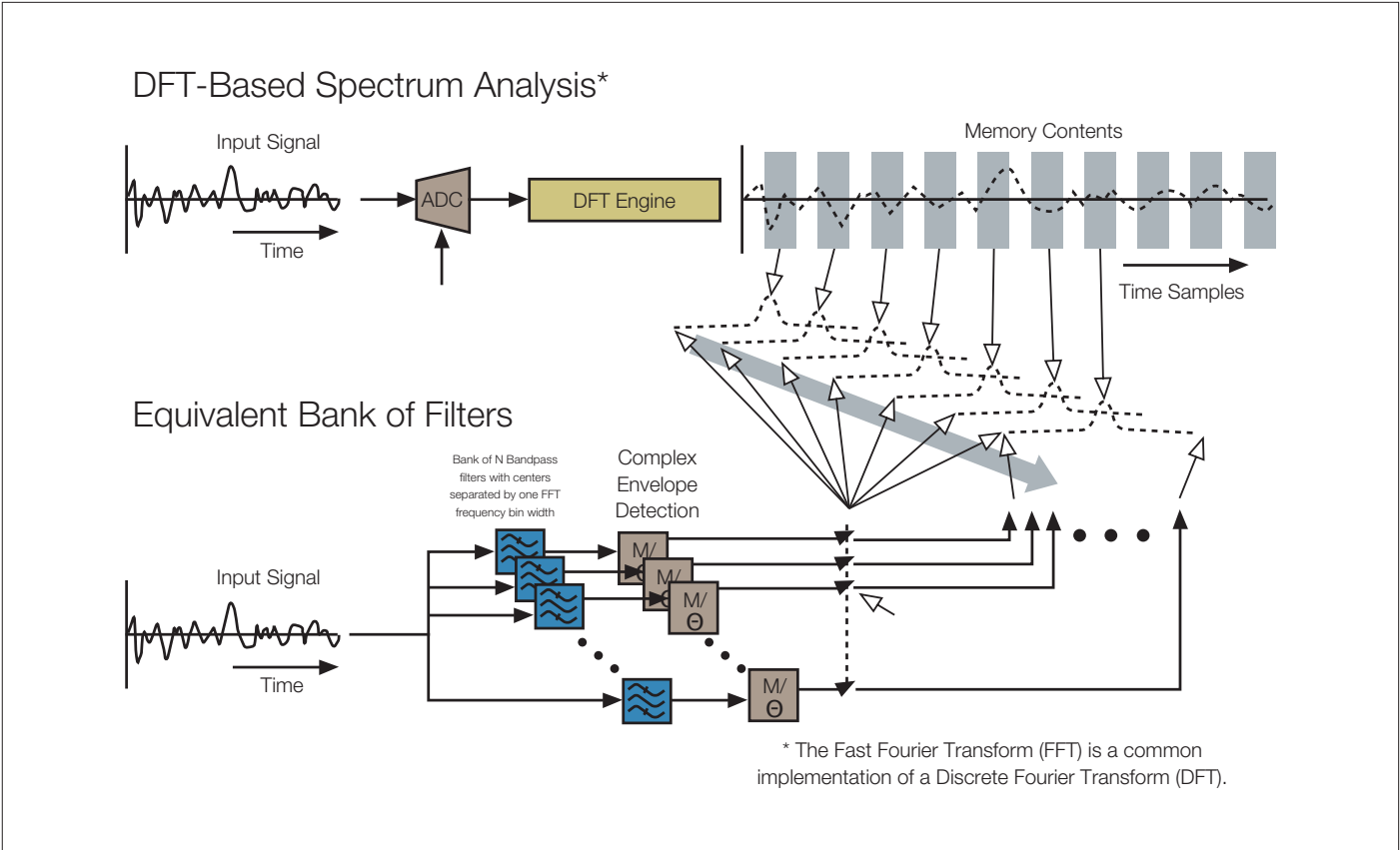

Figure 2-5. A DFT-based Spectrum Analyzer and an equivalent implementation using a bank of bandpass filters.

Transforming Time Domain Waveforms to the Frequency Domain

Spectrum analysis, also called Fourier analysis, separates the various frequency components of an input signal. The typical spectrum analyzer display plots the level of the individual frequency components versus frequency. The difference between the start and stop frequencies of the plot is the span. Spectrum analysis is said to be real-time when

repetitive Discrete Fourier Transforms (DFTs) are performed as shown in Figure 2-5 is such a way that signal processing keeps up with the input signal. Repetitive Fourier transforms can also be used to discover, capture and analyze infrequent transient events in the frequency domain even when the requirements for real-time are not strictly met.

Real-Time Spectrum Analysis

For spectrum analysis to be classified real-time, all information contained within the span of interest must be processed indefinitely without gaps. An RTSA must take all information contained in time domain waveform and transform it into frequency domain signals. To do this in real-time requires several important signal processing requirements:

- Enough capture bandwidth to support analysis of the signal of interest
- A high enough ADC clock rate to exceed the Nyquist criteria for the capture bandwidth
- A long enough analysis interval to support the narrowest resolution bandwidth (RBW) of interest
- A fast enough DFT transform rate to exceed the Nyquist criteria for the RBW of interest
- DFT rates exceeding the Nyquist criteria for RBW require overlapping DFT frames:
 - The amount of overlap depends on the window function
 - The window function is determined by the RBW

Today's RTSAs meet the real-time requirements listed above for Frequency Mask Trigger (FMT) for spans up to their maximum real-time acquisition bandwidth. Triggering on frequency domain events, therefore, considers all the information contained in the selected acquisition bandwidth.

Discovering and Capturing Transient Events

Another application of fast and repetitive Fourier transforms is the discovery, capture and observation of rare events in the frequency domain. A useful specification is the minimum event duration for 100% probability of capturing a single non-repetitive event. A minimum event is defined as the narrowest rectangular pulse that can be captured with 100% certainty at the specified accuracy. Narrower events can be detected, but the accuracy and probability may degrade. Discovering, capturing and analyzing transients requires:

- Enough capture bandwidth to support analysis of the signal of interest
- A high enough ADC clock rate to exceed the Nyquist criteria for the capture bandwidth
- A long enough analysis interval to support the narrowest resolution bandwidth (RBW) of interest
- A fast enough DFT transform rate to support the minimum event duration

At 48000 spectrums per second, the DPX Spectrum mode in the RSA6100 Series can detect RF pulses as short as 24 microseconds with the full accuracy specifications with 100% probability. A Swept Spectrum Analyzer (SA) with 50 sweeps per second requires pulses longer than 20 milliseconds for 100% probability of detection with full accuracy.

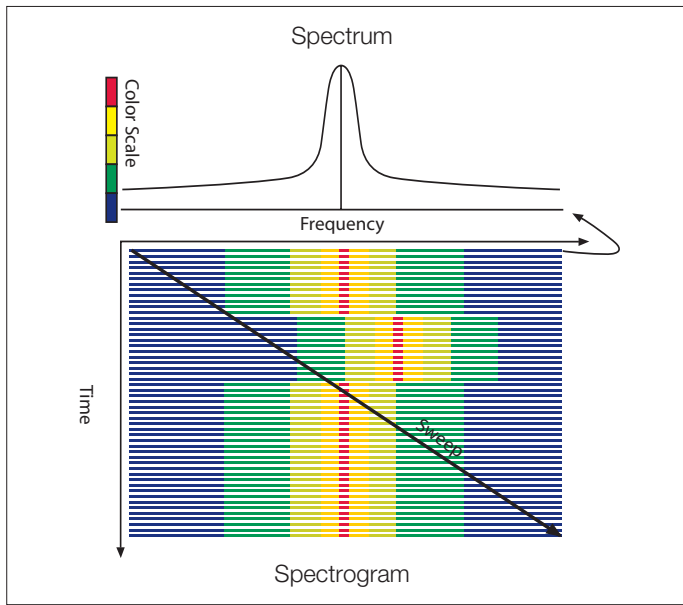

Figure 2-6. Spectrum, Spectrogram and Sweep.

Relating RTSA to Swept Spectrum Analyzer

Consider a RTSA system as described on the previous page. A passband of interest is downconverted to an IF and digitized. The time domain samples are digitally converted to a baseband record composed of a sequence of I (in-phase) and Q (quadrature) samples. DFTs are sequentially performed on segments of the IQ record generating a mathematical representation of frequency occupancy over time, as shown in Figure 2-5 (on page 16).

Taking sequential equally spaced DFTs over time is mathematically equivalent to passing the input signal through a bank of bandpass filters and then sampling the magnitude and phase at the output of each filter. The frequency domain behavior over time can be visualized as a spectrogram as shown in Figure 2-6, where frequency is plotted horizontally, time is plotted vertically and the amplitude

is represented as a color. The real-time DFT effectively samples the entire spectrum of the incoming signal at the rate with which new spectrums are computed. Events occurring between the time segments on which the FFTs are performed are lost. RTSAs minimize or eliminate the “dead time” by performing hardware-based DFTs, often performing transforms on overlapping time segments at the fastest sample rate.

An SA, in contrast, is tuned to a single frequency at any given time. The frequency changes as the sweep advances tracing the diagonal line in Figure 2-6. The slope of the line becomes steeper as the sweep slows so that the function of a spectrum analyzer in zero-span can be represented as a vertical line indicating that the instrument is tuned to a single frequency as time advances. Figure 2-6 also shows how a sweep can miss transient events such as the single frequency hop depicted.

RBW on the Real-Time Spectrum Analyzer

Frequency resolution is an important spectrum analyzer specification. When we try to measure signals that are close in frequency, frequency resolution determines the capability of the spectrum analyzer to distinguish between them. On traditional SAs, the IF filter bandwidth determines the ability to resolve adjacent signals and is also called the resolution bandwidth (RBW). For example, in order to resolve two signals of equal amplitude and 100 kHz apart in frequency, RBW needs to be less than 100 kHz.

For spectrum analyzers based on the DFT technique, the RBW is inversely proportional to the acquisition time. Given the same sampling frequency, more samples are required to achieve a smaller RBW. In addition, windowing also affects the RBW.

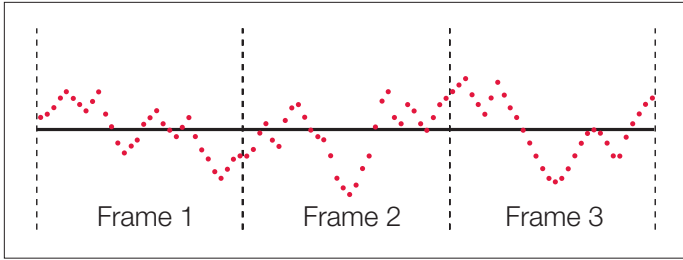

Figure 2-7. Three frames of a sampled time domain signal.

Windowing

There is an assumption inherent in the mathematics of Discrete Fourier Transform (DFT) analysis that the data to be processed is a single period of a periodically repeating signal. Figure 2-7 depicts a series of time domain samples. When DFT processing is applied to Frame 2 in Figure 2-7, for example, the periodic extension is made to the signal. The discontinuities between successive frames will generally occur as shown in Figure 2-8.

These artificial discontinuities generate spectral artifacts not present in the original signal. This effect produces an inaccurate representation of the signal and is called spectral leakage. Spectral leakage not only creates signals in the output that were not present in the input, but also reduces the ability to observe small signals in the presence of nearby large ones.

Tektronix Real-Time Spectrum Analyzers apply a windowing technique to reduce the effects of spectral leakage. Before performing the DFT, the DFT frame is multiplied by a window function with the same length sample by sample. The window

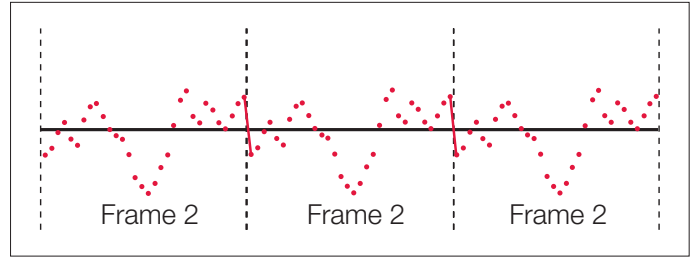

Figure 2-8. Discontinuities caused by periodic extension of samples in a single frame.

functions usually have a bell shape, reducing or eliminating the discontinuities at the ends of the DFT frame.

The choice of window function depends on its frequency response characteristics such as side-lobe level, equivalent noise bandwidth, and amplitude error. The window shape also determines the effective RBW filter.

Like other spectrum analyzers, the RTSAs allow the user to select the RBW filter. The RTSAs also allow the user to select among many common window types. The added flexibility to directly specify the window shape enables the users to optimize for specific measurements. Special attention, for example, should be paid to the spectrum analysis of pulse signals. If the pulse duration is shorter than the window length, uniform window (no windowing) should be used to avoid de-emphasizing effects on both ends of the DFT frame. For further information on this topic, please refer to the Tektronix Primer, "Understanding FFT Overlap Processing on the Real-Time Spectrum Analyzer" (37W-18839).

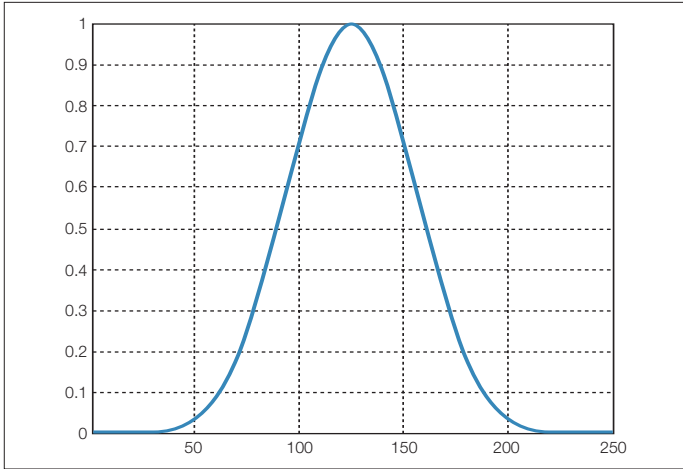

Figure 2-9. Kaiser Window (beta 16.7) in Time Domain (Horizontal is time sample, Vertical is linear scale).

The magnitude of the frequency response of the window function determines the RBW shape. For example, the RBW on RSA6100 is defined as the 3 dB bandwidth and is related to the sampling frequency and samples in the DFT as follows:

$$RBW = \frac{k * F_s}{N} \quad \text{Equation 1}$$

or

$$N = \frac{k * F_s}{RBW} \quad \text{Equation 2}$$

Where k is a window-related coefficient, N is the number of time-domain samples used in the DFT calculation, and F_s is the sampling frequency. For the Kaiser window with beta¹ 16.7, k is about 2.23. The RBW shape factor, defined as the frequency ratio between the spectrum amplitude at 60 dB and 3 dB, is about 4:1. On the RSA6100, the spectrum analysis measurement uses Equation 2 to calculate the required number of samples for the DFT based on the input span and RBW settings.

The time domain and the spectrum of the Kaiser window used for RSA6100 spectrum analysis is shown in Figure 2-9 and Figure 2-10. This is the default window used in the RSA6100 for spectrum analysis. Other windows (such as Blackman-Harris, Uniform, Hanning) may be user-selected to meet special measurement requirements, and may be used by the instrument when performing some of the measurements available in the instrument.

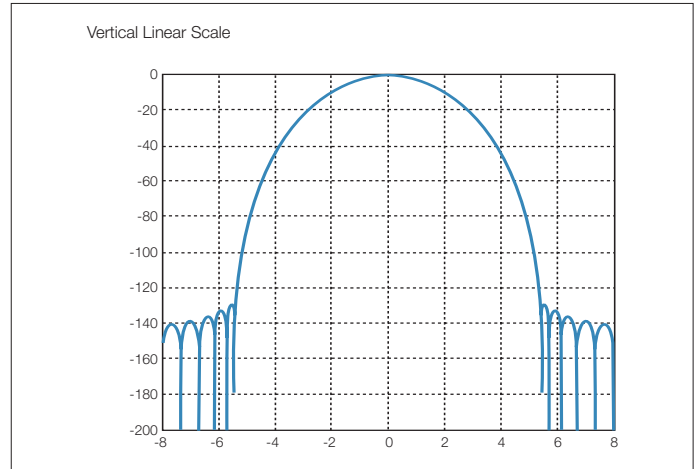

Figure 2-10. The spectrum of a Kaiser window (beta 16.7). The horizontal scale unit is the frequency bin (F_s/N). The vertical scale is in dB.

Discrete Fourier Transforms (DFT) in the Real-Time Spectrum Analyzer

The DFT is defined below:

$$X[k] = \sum_{n=0}^{N-1} x(n) e^{-j2\pi kn/N}$$

This is the basis of a real-time spectrum analyzer and it is used to estimate the individual frequency components $x(k)$ from the input sequence $x(n)$. The DFT is block-based and N is the total sample number of each DFT block (or Frame). The input sequence $x(n)$ is a sampled version of the input signal $x(t)$. Although the input sequence is only defined for integer values of n, the output is a continuous function of k, where $k=(N\Omega)/(2\pi)$ and Ω is the radian frequency. The magnitude of $X[k]$ represents the magnitude of the frequency component at frequency Ω that is present in the input sequence $x(n)$.

There are various efficient methods to compute the DFT. Examples include the Fast Fourier Transform (FFT) and the Chirp-Z Transform (CZT). The choice of implementation method depends on the particular needs of the application. The CZT, for example, has greater flexibility in choosing the frequency range and the number of output points than the FFT. The FFT is less flexible but requires fewer computations. Both the CZT and the FFT are used in RTSAs.

[Reference 1] Oppenheim, A.V. and R.W. Schaffer, Discrete-time Signal Processing, Prentice-Hall, 1989, p. 453.

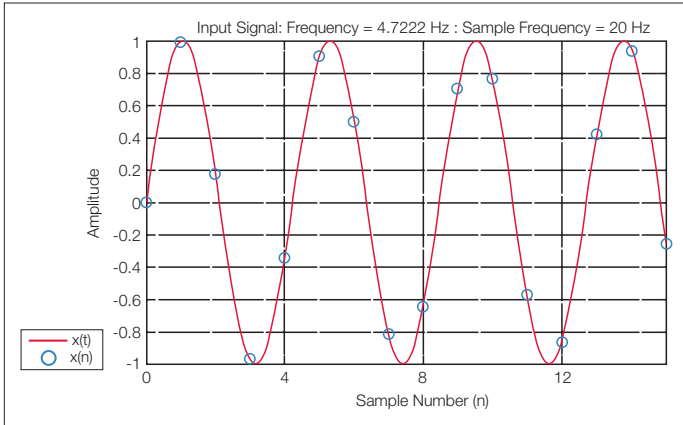

Figure 2-11. Input Signal.

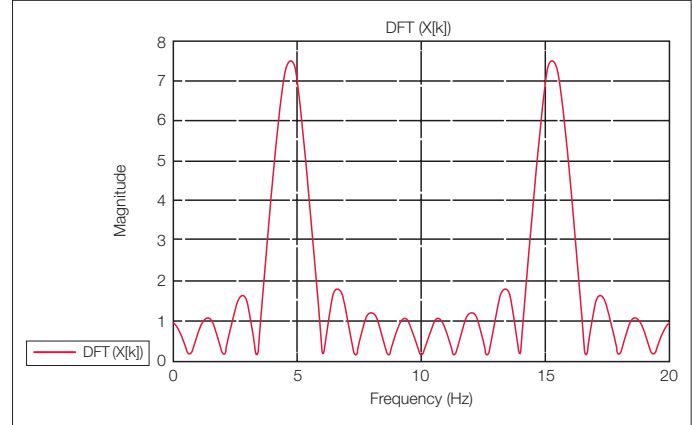

Figure 2-12. DFT of $x(n)$ evaluated continuously.

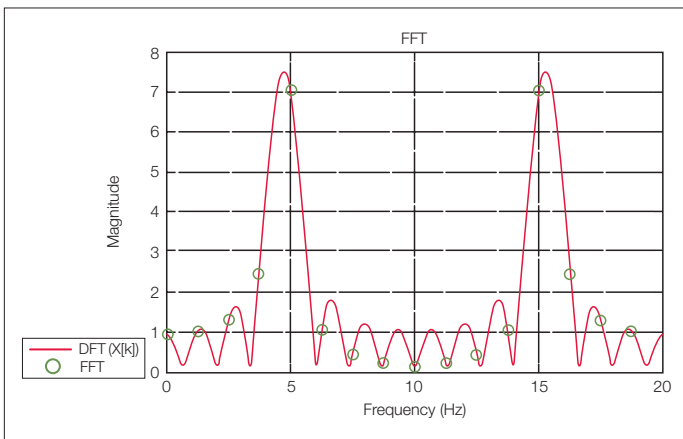

Figure 2-13. FFT of $x(n)$, length of FFT = N = length of $x(n)$.

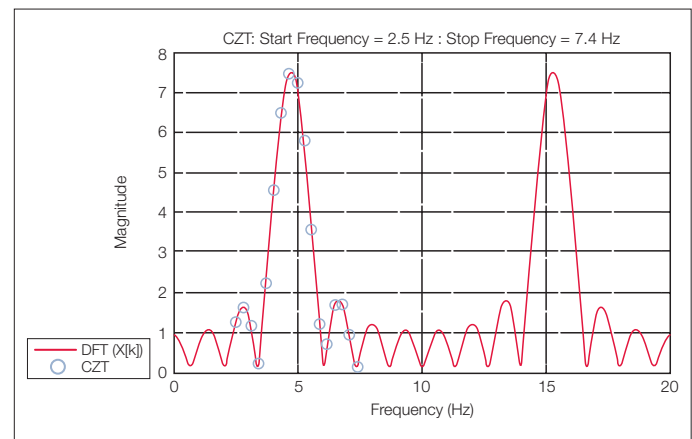

Figure 2-14. CZT of $x(n)$.

The ability to resolve frequency components is not dependent on the particular implementation of the DFT and is determined by the time length of the input sequence or the RBW.

To illustrate the relationship of the DFT to the FFT and the CZT, a sampled Continuous Waveform (CW) signal will be analyzed. For illustration purposes a real-valued sine wave $x(t)$ will be used as the input signal (Figure 2-11). The sample version of $x(t)$ is $x(n)$. In this case $N = 16$ and the sample rate is 20 Hz.

Figure 2-12 shows the result of evaluating the DFT for $0 \leq k < N$. Note that the magnitude of $X[k]$ for $\Omega > \pi$ ($f > 10$ Hz) is a mirror image of the first half. This is the result for a real-valued input sequence $x(n)$. In practice, the results from $\pi < \Omega < 2\pi$ are discarded (or not computed) when a real input signal is analyzed. For a complex input, a unique result can be obtained for $0 \leq \Omega < 2\pi$ ($0 \leq f < 20$ Hz).

A FFT returns N -equally spaced frequency domain samples of $X[k]$. The magnitude of $X[k]$ is shown in Figure 2-13. Note that the samples returned by the FFT might miss the peaks of magnitude of $X[k]$.

A CZT can return M frequency domain samples with an arbitrary start and stop frequency (Figure 2-14). Notice that the CZT does not change the underlying frequency domain output of the DFT. It only takes a different set of frequency domain samples than the FFT.

An advantage of using the CZT is that the frequency of the first and last sample in the frequency domain can be arbitrarily selected and does not depend on the input sample rate. The same result can also be achieved by arbitrarily controlling the input sample rate so that the output of the FFT produces the same output samples as the CZT. The end result is the same in both cases. The choice is purely an implementation issue, and depending on the requirements and available HW, one or the other will be a more optimal solution.

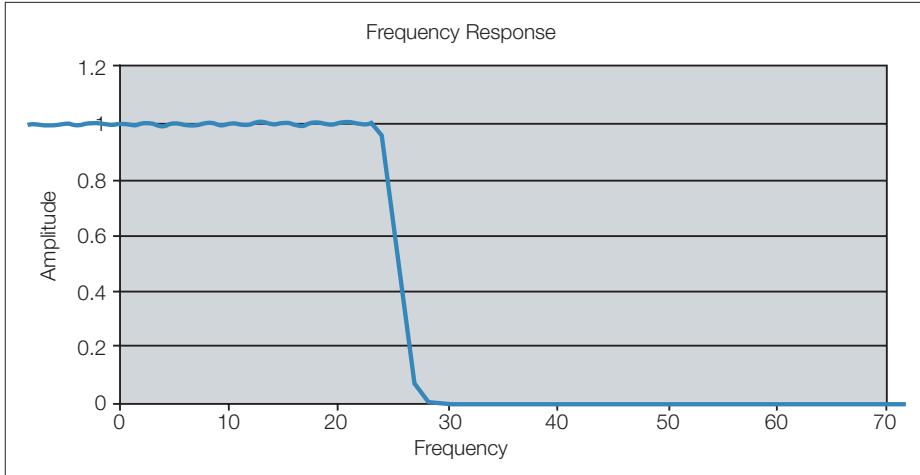

Figure 2-15. Frequency response of a lowpass filter.

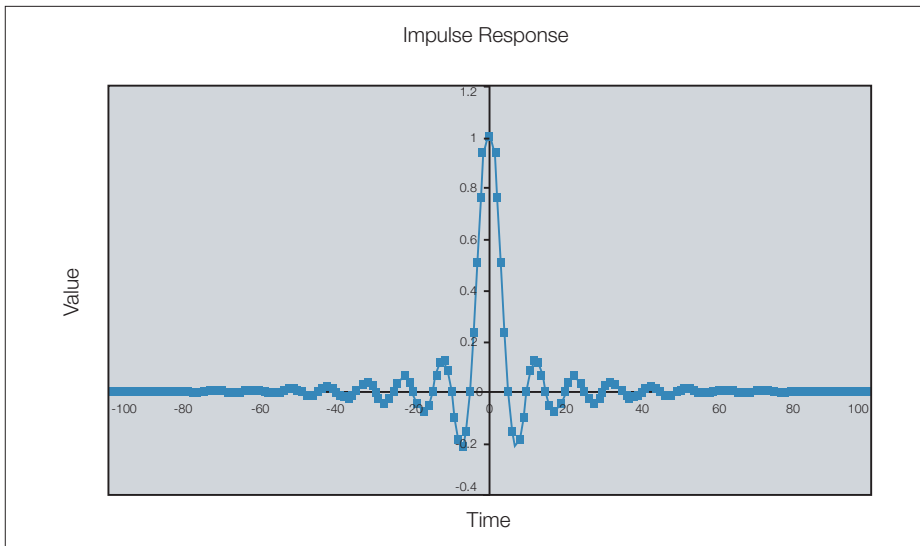

Figure 2-16. Impulse response for the lowpass filter in Figure 2-15.

Digital Filtering

Finite Impulse Response (FIR) Filters

Frequency filters are used in many applications to select some frequencies and reject others. While traditional filters are implemented using analog circuit elements (RLC),

DSP selects the frequencies to be enhanced or attenuated mathematically. A common mathematical implementation is the Finite Impulse Response (FIR) filter. RTSAs make extensive use of FIR filters. In addition to the usual signal conditioning applications requiring the passage or rejection of specific bands, FIR filters are also used to adjust for analog signal path imperfections. Internally generated alignment data is combined with stored factory calibration data to create FIR filters with a response that compensates for the analog signal path frequency response, making the cascade of the analog and digital paths have flat amplitude response and linear phase.

Frequency Response vs. Impulse Response

The theory of Fourier transforms shows an equivalency between the frequency domain and the time domain. It further tells us that the transfer function of a device, usually expressed as its amplitude and phase response over frequency, is equivalent to the impulse response over time. A FIR filter emulates the impulse response of the desired filter transfer function with a discrete-time approximation that has finite time-

duration. Signal filtering is then performed by convolving the input signal with the impulse response of the filter.

Figure 2-15 shows the magnitude of the transfer function of a lowpass filter. Figure 2-16 shows its impulse response.

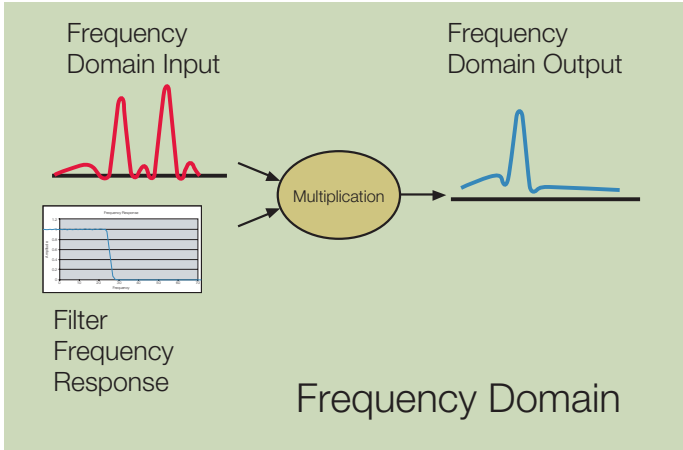

Figure 2-17. Multiplying a filter by its frequency response.

Numerical Convolution

The frequency domain is often used to analyze the responses of linear systems such as filters. Signals are expressed in terms of their frequency content. The spectrum of the signal at the output of a filter is computed by multiplying the input signal spectrum by the frequency response of the filter. Figure 2-17 illustrates this frequency domain operation.

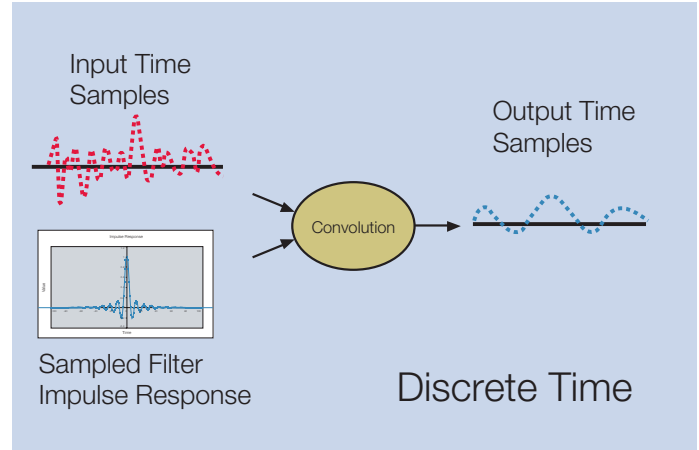

Figure 2-18. Convolution in the time domain is equivalent to multiplication in the frequency domain.

Fourier theory states that a multiplication in the frequency domain is the equivalent of a convolution in the time domain. The frequency domain multiplication shown above is equivalent to convolving the time domain representation of the input signal with the impulse response of the filter as shown in Figure 2-18.

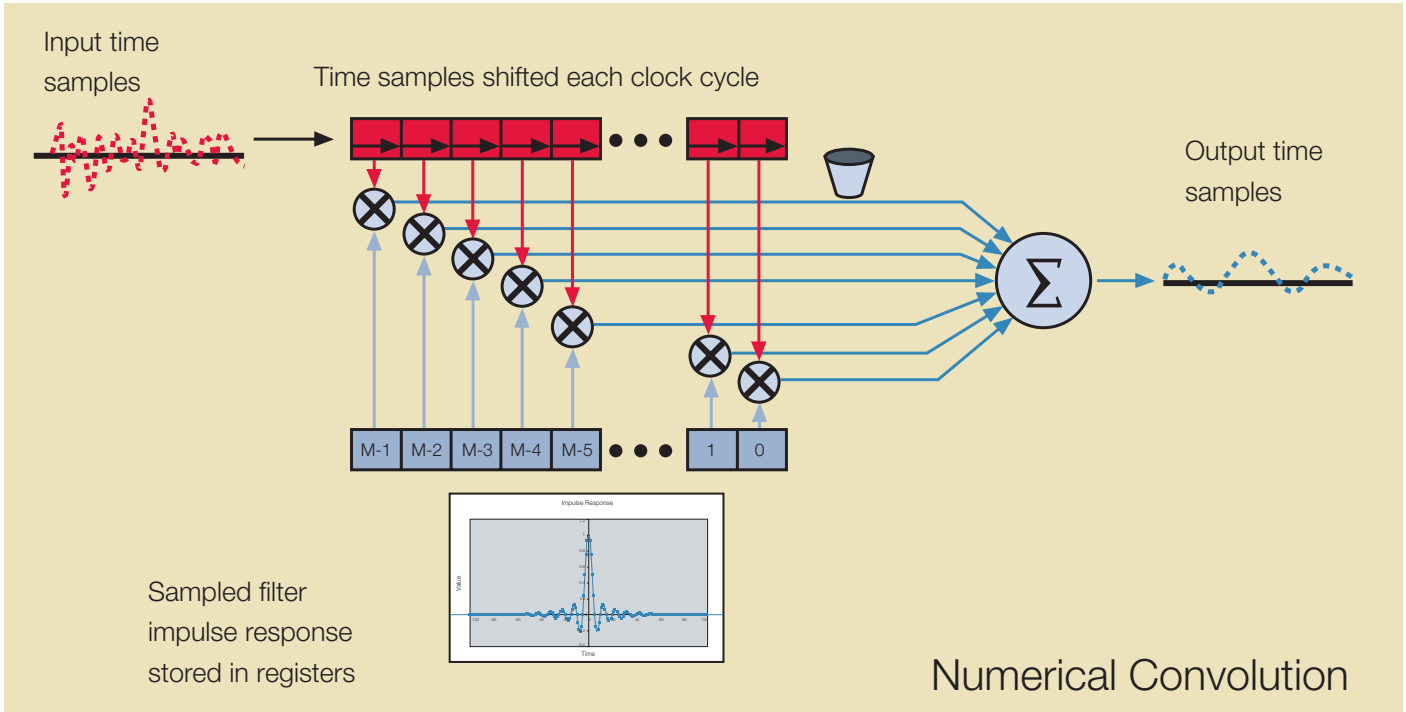

Figure 2-19. Discrete Time Numerical Convolution.

All frequency filters involve the use of memory elements. Capacitors and inductors, the common reactive elements used in analog filters, have memory since their output in a circuit depends on the current input as well as the input at previous points in time. A discrete time filter can be constructed using actual memory elements as shown in Figure 2-19.

The lower registers are used to store values of the filter's impulse response with the earlier samples on the right and the later samples on the left. The upper registers are used to shift the input signal from left to right with one shift each clock cycle. The contents of each corresponding register are multiplied together and all of the resulting products are summed each clock cycle. The result of the sum is the filtered signal.

In summary, the RTSA relies heavily on digital signal processing for spectrum analysis. Key points of DSP as applied to the RTSAs are:

- The RSA6100 uses a combination of FFTs and CZTs to achieve spectrum displays.
 - FFTs are more computationally efficient, allowing faster transform rates, but CZTs are more flexible, allowing variable resolution bandwidths for a fixed set of input samples.
 - The resolution bandwidth (RBW) shape is achieved by applying an optimized window function to the time domain signals before performing a Fourier transform. RBWs are specified by their 3 dB bandwidth and 60 dB:3 dB shape factor, in the same fashion as an analog implementation. In general, the shape factor of the digitally implemented filter is lower (sharper) than an analog implementation, yielding easier resolution of closely spaced signals of widely different amplitudes.

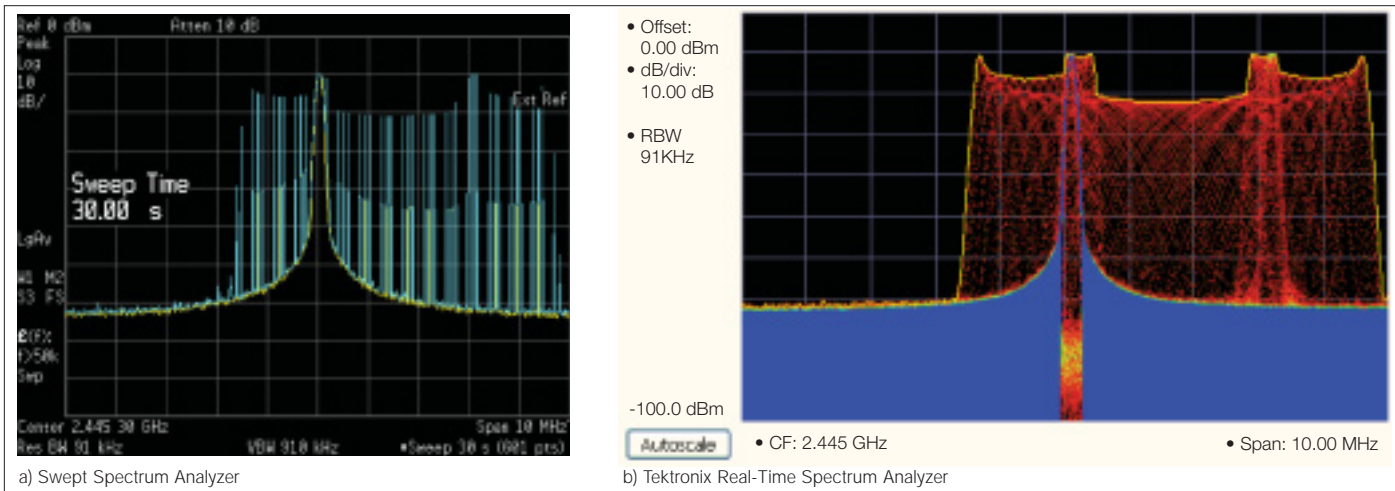

Figure 2-20 a, b. Comparison (a), Swept Spectrum Analyzer MaxHold trace after 120 seconds and (b), Tektronix Real-Time Spectrum Analyzer with DPX bitmap MaxHold trace after 20 seconds.

- Other shape factors can be used for special applications by applying optimized window functions.
- The RSA3000 Series RTSA uses a combination of methods when performing spectrum analysis.
 - In Spectrum mode, the result of a windowed FFT is convolved with a RBW shape to yield Spectrum traces with a specified RBW, similar to an analog spectrum analyzer. This process yields a slightly wider shape factor of approximately 5:1, compared to 4.1:1 for the RSA6100.
 - In DPX mode, CZTs are used for resolution bandwidth flexibility.
 - In RTSA mode, windowed FFTs are used, specified in the classical method for FFT analysis, that of the Noise Bandwidth. The Noise Bandwidth is approximately 6% (0.25 dB) greater than the RBW.

DPX™ Technology: a Revolutionary Tool for Signal Discovery

Tektronix' patented Digital Phosphor technology or DPX reveals signal details that are completely missed by conventional spectrum analyzers and VSAs (Figure 2-20). The DPX Spectrum's Live RF display shows signals never seen before, giving users instant insight and greatly accelerating problem discovery and diagnosis. DPX is a standard feature in all Tektronix RTSAs.

As we have seen in this section, digitally implemented corrections and filtering are a key factor in implanting the high transform rate required of a RTSA. The next section looks at the practical use of these filters in one of the unique displays available in the RTSA, the Digital Phosphor Spectrum Display.

Digital Phosphor Display

The name “Digital Phosphor” derives from the phosphor coating on the inside of cathode ray tubes (CRTs) used as displays in older televisions, computer monitors and test equipment where the electron beam is directly controlled by the input waveform. When the phosphor is excited by an electron beam, it fluoresces, lighting up the path drawn by the stream of electrons.

Liquid Crystal Displays (LCDs) replaced CRTs in many applications due to their smaller depth and lower power requirements, among other advantages. However, the combination of phosphor coatings and vector drawing in CRTs provided several valuable benefits.

Persistence: Phosphor continues to glow even after the electron beam has passed by. Generally, the fluorescence fades quickly enough that viewers don’t perceive it lingering, but even a small amount of persistence will allow the human eye to detect events that would otherwise be too short to see.

Proportionality: The slower the electron beam passes through a point on the phosphor-coated screen, the brighter the resulting light. Brightness of a spot also increases as the beam hits it more frequently. Users intuitively know how to interpret this z-axis information: a bright section of the trace indicates a frequent event or slow beam motion, and a dim trace results from infrequent events or fast-moving beams. In the DPX display, both color and brightness provide z-axis emphasis.

Persistence and proportionality do not come naturally to instruments with LCDs and a digital signal path. Tektronix developed Digital Phosphor technology so the analog benefits of a variable persistence CRT could be achieved, and even improved upon, in our industry-leading digital oscilloscopes and now in our RTSAs. Digital enhancements such as intensity grading, selectable color schemes and statistical traces communicate more information in less time.

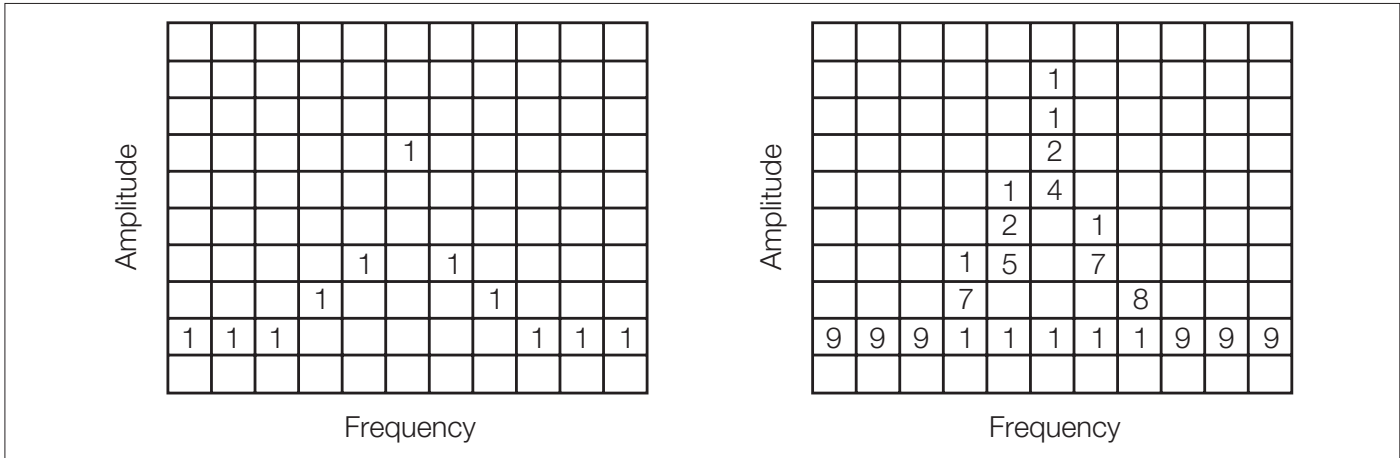

Figure 2-21. Example 3-D Bitmap Database after 1 (left) and 9 (right) updates. Note that each column contains the same total number of "hits."

The DPX Display Engine

Performing thousands of spectral measurements per second and updating the screen at a live rate is an oversimplified description of the role DPX technology performs in an RTSA. Thousands of acquisitions are taken and transformed into spectrums every second. This high transform rate is the key to detecting infrequent events, but it is far too fast for the LCD to keep up with, and it is well beyond what human eyes can perceive. So the incoming spectrums are written into a bitmap database at full speed then transferred to the screen at a viewable rate. Picture the bitmap database as a dense grid created by dividing a spectrum graph into rows representing trace amplitude values and columns for points on the frequency axis. Each cell in this grid contains the count of how many times it was hit by an incoming spectrum. Tracking these counts is how Digital Phosphor implements proportionality, so you can visually distinguish rare transients from normal signals and background noise.

The actual 3-D database in an RTSA contains hundreds of columns and rows, but we will use an 11X10 matrix to illustrate the concept. The picture on the left in Figure 2-21 shows what the database cells might contain after a single spectrum is mapped into it. Blank cells contain the value zero, meaning that no points from a spectrum have fallen into them yet.

| Number of Occurrences | Color |
|-----------------------|------------|
| 0 | black |
| 1 | blue |
| 2 | light blue |
| 3 | cyan |
| 4 | green blue |
| 5 | green |
| 6 | yellow |
| 7 | orange |
| 8 | red orange |
| 9 | red |

Figure 2-22. Example Color-Mapping Algorithm.

The grid on the right shows values that our simplified database might contain after an additional eight spectral transforms have been performed and their results stored in the cells. One of the nine spectrums happened to be computed at a time during which the signal was absent, as you can see by the string of "1" values at the noise floor.

When we map the Number of Occurrences values to a color scale, data turns into information. The table found in Figure 2-22 shows the color-mapping algorithm that will be used for this example. Warmer colors (red, orange, yellow) indicate more occurrences. Other intensity-grading schemes can also be used.

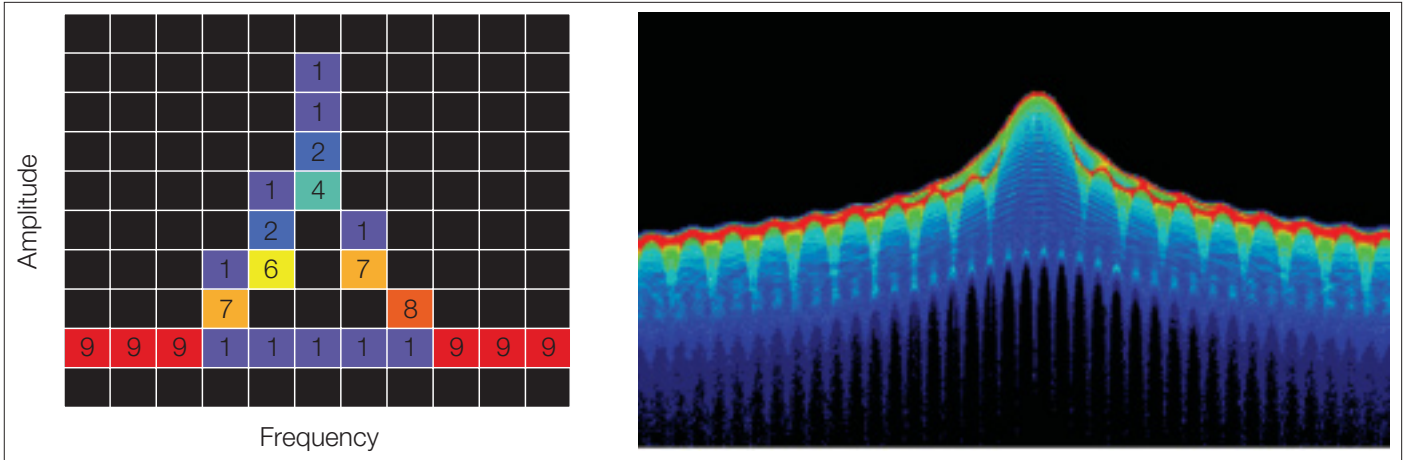

Figure 2-23. Color-coded low-resolution example with Temperature Bitmap (left), and a real DPX display (right) shown with Spectrum Bitmap.

In Figure 2-23, the left image is the result of coloring the database cells according to how many times they were written into by the nine spectrums. Displaying these colored cells, one per pixel on the screen, creates the spectacular DPX displays, as seen in the right image.

Persistence

In the RSA6100 Series, for example, 48,000+ spectrums enter the database each second. At the end of each frame of 1400+ input spectrums (about 33 times per second), the bitmap database is transferred out for additional processing before being displayed, and data from a new frame starts filling the bitmap.

To implement persistence, the DPX engine can keep the existing counts and add to them as new spectrums arrive, rather than clearing the bitmap database counts to zero at the start of each new frame. Maintaining the full count values across frames is “infinite persistence.” If only a fraction of each count is carried over to the next frame, it is called

“variable persistence.” Adjusting the fraction changes the length of time it takes for a signal event to decay from the database, and thus fade from the display.

Imagine a signal that popped up only once during the time DPX was running. Further, assume that it was present for all 1465 of the spectrum updates in a frame and that the Variable Persistence Factor causes 25% attenuation after each frame. The cells it affected would start out with a value of 1465 and be displayed at full force. One frame later, the Number of Occurrences values become 1099. After the next frame, they are 824, then smaller and smaller until they are so dim as to be invisible. On the screen, you would initially see a bright trace with a spike at the signal frequency. The part of the trace where the signal occurred fades away. During this time, the pixels start to brighten at the noise level below the fading signal. In the end, there is only a baseline trace in the display (Figure 2-24, on the next page).

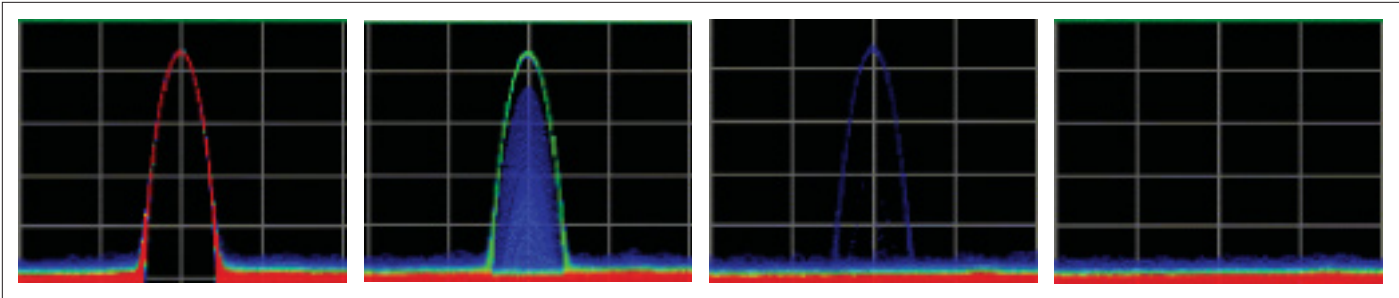

Figure 2-24. With variable persistence, a brief CW signal captured by DPX remains in the display for an adjustable period of time before fading away.

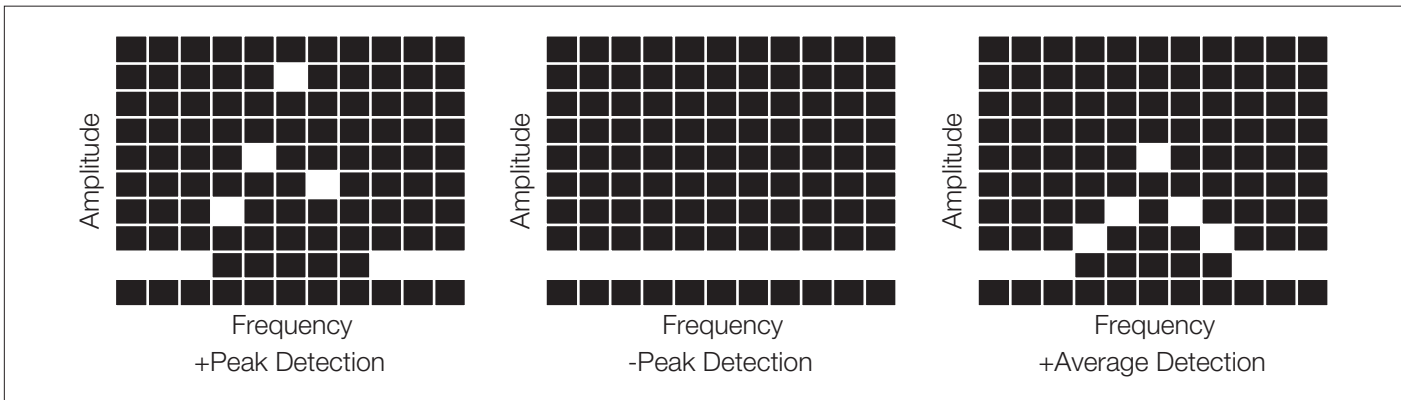

Figure 2-25. Detected traces example: +Peak Detection (left); -Peak Detection (middle); and Average Detection (right).

Persistence is an extremely valuable troubleshooting aid, delivering all the benefits of MaxHold and more. To find out if there is an intermittent signal or occasional shift in frequency or amplitude, you can turn on Infinite Persistence and let the RTSA baby-sit. When you return, you will see not only the highest level for each frequency point, but also the lowest levels and any points in between. Once the presence of transient behavior or intruding signals has been revealed, you can characterize the problem in detail with Variable Persistence.

Statistical Line Traces

A colorful bitmap is DPX Spectrum's signature trace, but DPX also produces statistical line traces. The database contents are queried for the highest, lowest and average amplitude values recorded in each frequency column. The three resulting trace detections are +Peak, -Peak and Average (Figure 2-25).

The +Peak and -Peak traces show signal maxima and minima instantly and clearly. Average detection finds the mean level for the signal at each frequency point. All these traces can be saved and restored for use as reference traces.

Just like regular spectrum traces, DPX line traces can be accumulated over ongoing acquisitions to yield MaxHold, MinHold and Average trace functions. Using Hold on the DPX +Peak trace is almost exactly the same as the MaxHold trace on a typical spectrum analyzer, with the important difference that the DPX trace's update rate is orders of magnitude faster.

The DPX Transform Engine

So how do all those spectrums get generated? In parallel with the software batch processing used for most measurements, and using the same stream of incoming IQ data, there is a hardware-based computation engine devoted to continuous, real-time signal processing. This subsystem supports time-critical functions like power-level triggering, frequency mask triggering and others. It also performs DFTs fast enough to produce the spectrum rate used by the DPX display system.

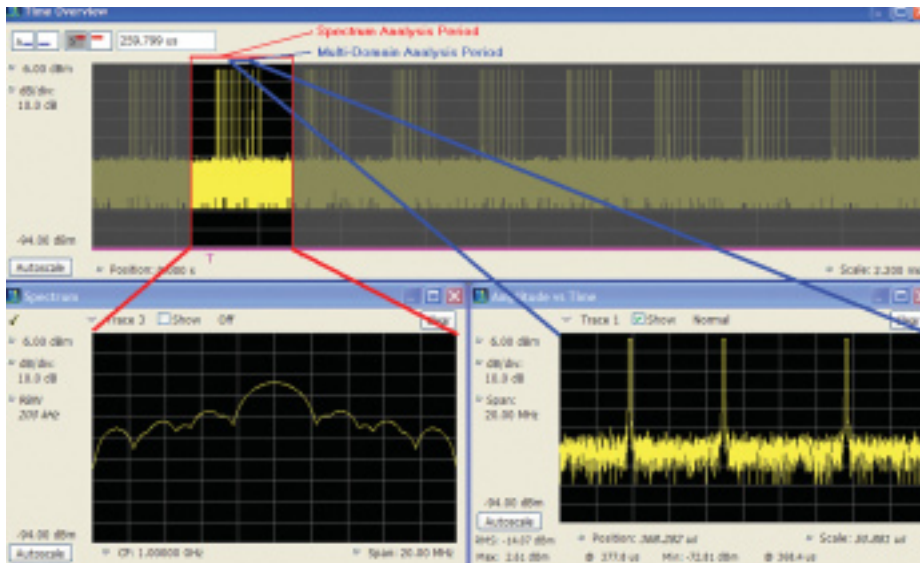

Figure 2-26. Time overview with spectrum length and multi-domain analysis length indicators as shown in the RSA6100.

The **spectrum length** determines the length of time for which spectrum displays are calculated. The **spectrum offset** determines the delay or advance from the instant of the trigger event until the beginning of the FFT frame that is displayed. Both spectrum length and spectrum offset have a time resolution of one FFT frame. While the RSA3000 Series uses a fixed FFT length, the added flexibility of the high performance RSA6100 Series analyzers allow one to vary the FFT length for spectrum viewing. Tektronix RTSAs indicate the spectrum offset and spectrum length using a colored bar at the bottom of the time domain overview window. The bar color is keyed to the pertinent display.

Timing and Triggers

Real-time processing enables the DPX display that makes the RTSA a powerful discovery tool. However, the DPX display does not keep a time domain record that can re-analyzed in multiple domains. Capture and additional analysis requires that the signal be written into memory, and that the area of interest in the waveform be selected for analysis. This section illustrates the triggering, acquisition and analysis period controls of the RTSA, seen in Figure 2-26 (RSA6100 Series).

The timing controls, when used in conjunction with triggers, offer a powerful combination for analyzing transient or other timing related parameters.

The **acquisition length** specifies the length of time for which samples will be stored in memory in response to a trigger. The **acquisition history** determines how many previous acquisitions will be kept after each new trigger. Tektronix RTSAs show the entire acquisition length in the time domain overview window.

The **analysis length** determines the length of time for which modulation analysis and other time-based measurements are made. The analysis offset determines the delay or advance from the instant of the trigger until the beginning of the analysis. Tektronix RTSAs indicate the analysis offset and length using a colored bar at the bottom of the time domain overview window. The bar color is keyed to the pertinent display.

The **output trigger indicator** allows the user to selectively enable a TTL rear-panel output at the instant of a trigger. This can be used to synchronize RTSA measurements with other instruments such as oscilloscopes or logic analyzers.

Real-Time Triggering and Acquisition

The RTSA is capable of performing time, spectrum, and modulation analysis. Triggering is critical to capturing time domain information. The RTSA offers unique trigger functionality, providing power and FMTs as well as the usual power, external and level-based triggers.

The most common trigger system is the one used in most oscilloscopes. In traditional analog oscilloscopes, the signal to be observed is fed to one input while the trigger is fed to another. The trigger event causes the start of a horizontal sweep while the amplitude of the signal is shown as a vertical displacement superimposed on a calibrated graticule. In its simplest form, analog triggering allows events that happen after the trigger to be observed, as shown in Figure 2-27.

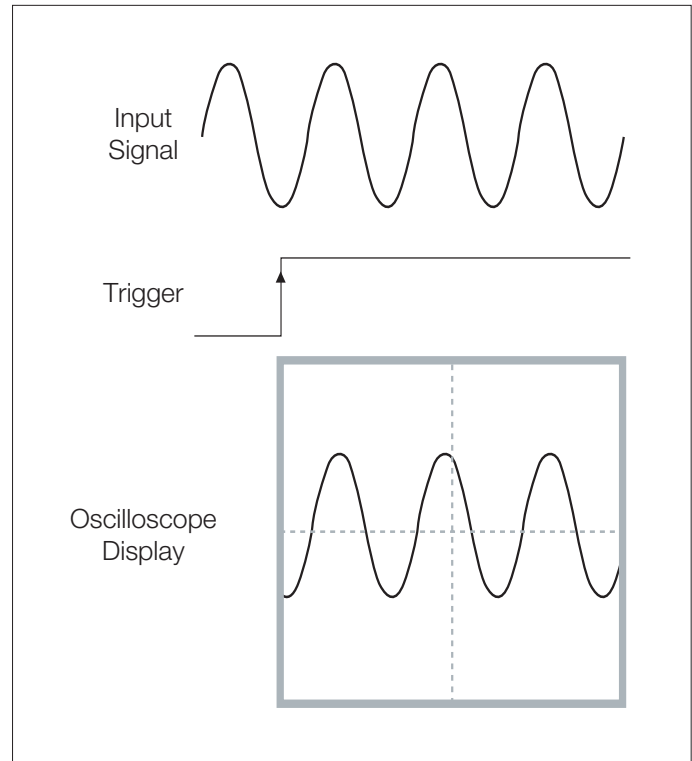

Figure 2-27. Traditional oscilloscope triggering.

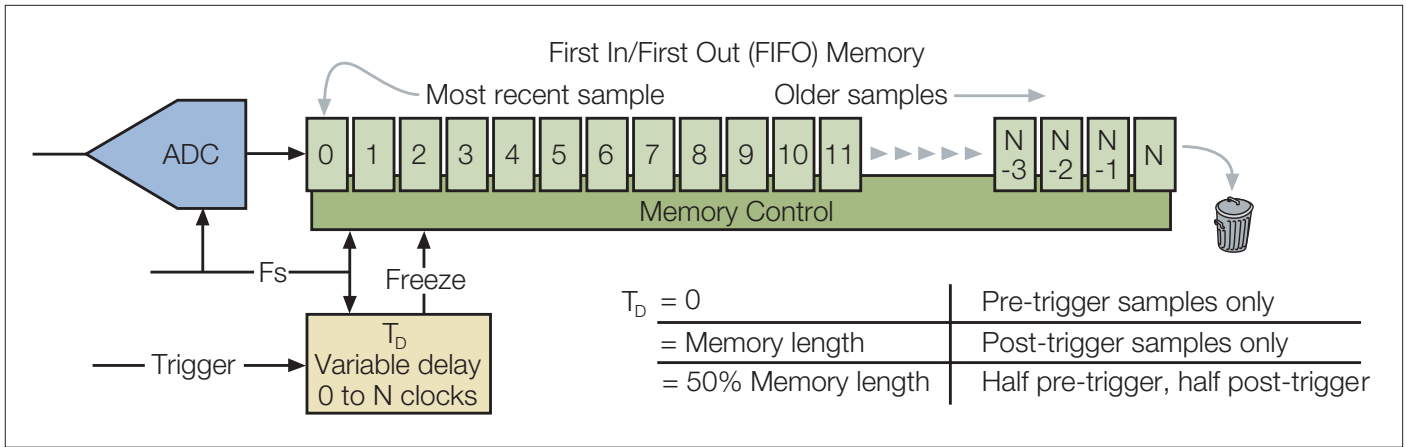

Figure 2-28. Triggering in digital acquisition systems.

Triggering in Systems with Digital Acquisition

The ability to represent and process signals digitally, coupled with large memory capacity, and allows the capture of events that happen before the trigger as well as after it.

Digital acquisition systems of the type used in Tektronix RTSAs use an Analog-to-Digital Converter (ADC) to fill a deep memory with time samples of the received signal. Conceptually, new samples are continuously fed to the memory while the oldest samples fall off. The example shown in Figure 2-28 shows a memory configured to store “N” samples. The arrival of a trigger stops the acquisition, freezing the contents of the memory. The addition of a variable delay in the path of the trigger signal allows events that happen before a trigger as well as those that come after it to be captured.

Consider a case in which there is no delay. The trigger event causes the memory to freeze immediately after a sample concurrent with the trigger is stored. The memory then contains the sample at the time of the trigger as well as

“N” samples that occurred before the trigger. Only **pre-trigger** events are stored.

Consider now the case in which the delay is set to match exactly the length of the memory. “N” samples are then allowed to come into the memory after the trigger occurrence before the memory is frozen. The memory then contains “N” samples of signal activity after the trigger. Only **post-trigger** events are stored.

Both post- and pre-trigger events can be captured if the delay is set to a fraction of the memory length. If the delay is set to half of the memory depth, half of the stored samples are those that preceded the trigger and half the stored samples followed it. This concept is similar to a trigger delay used in zero span mode of a conventional SA. The RTSA can capture much longer time records, however, and this signal data can subsequently be analyzed in the frequency, time, and modulation domains. This is a powerful tool for applications such as signal monitoring and device troubleshooting.

| Trigger Source | Trigger Signal | Setting Units | Time Uncertainty | Notes |
|------------------------|--|--|--|--|
| External | External trigger connector | Volts (variable) or TTL | RSA3300: ± 40 ns RSA3400: ± 20 ns RSA6100: ± 12 ns | RSA3000: 1 ext. trig Input RSA6100: 2 ext. trig Inputs (front and rear) |
| Power Level Trigger | Power calculated within current acquisition BW | Power, or dB relative to full scale | ±1 time domain points (based on effective sampling rate) | RSA6100 adds user-settable filter bandwidth to trigger |
| Frequency Mask Trigger | Point-by-point comparison at the output of a FFT processor | dB and Hz, based on the graphical mask drawn on screen | ±1 frame length | Frame length (based on effective sampling rate) |

Table 2-1. Comparison of Real-Time Spectrum Analyzers trigger sources.

Trigger Modes and Features

The **free-run** mode acquires samples of the received IF signal without the consideration of any trigger conditions. Spectrum, modulation or other measurements are displayed as they are acquired and processed.

The **triggered** mode requires a trigger source as well as the setting of various parameters that define the conditions for triggering as well as the instrument behavior in response to a trigger.

A selection of **continuous** or **single trigger** determines whether acquisitions repeat each time a trigger occurs or are taken only once each time a measurement is armed. The **trigger position**, adjustable from 0 to 100%, selects which portion of an acquisition block is pre-trigger. A selection of 10% captures pre-trigger data for one tenth of the selected block and post-trigger data for nine tenths. **Trigger slope** allows the selection of rising edges, falling edges or their combination for triggering. Rise and fall allows the capture of complete bursts. Fall and rise allows the capture of gaps in an otherwise continuous signal.

Real-Time Spectrum Analyzer Trigger Sources

Tektronix RTSAs provide several methods of internal and external triggering. Table 2-1 summarizes the various real-time trigger sources, their settings, and the time resolution that is associated with each one.

External triggering allows an external signal to control the acquisition. This is typically a control signal such as a frequency switching command from the system under test. This external signal prompts the acquisition of an event in the system under test.

Internal triggering depends on the characteristics of the signal being tested. The various RTSA models have the ability to trigger on the level of the digitized signal, on the power of the signal after filtering and decimation, or on the occurrence of specific spectral components using the FMT. Each of the trigger sources and modes offers specific advantages in terms of frequency selectivity, time resolution and dynamic range. The functional elements that support these features are shown in Figure 2-29 (on the next page).

Level triggering compares the digitized signal at the output of the ADC with a user-selected setting. The full bandwidth of the digitized signal is used, even when observing narrow spans that require further filtering and decimation. Level triggering uses the full digitization rate and can detect events with durations as brief as one sample at the full sampling rate. The time resolution of the downstream analysis, however, is limited to the decimated effective sampling rate. Level trigger is available on some RTSA models.

Power triggering calculates the power of the signal after filtering and decimation. The power of each filtered pair of IQ samples (I^2+Q^2) is compared with a user-selected power setting. Some RTSA models offer a filtered power trigger where a filter with a selectable bandwidth to be applied to the signal in the trigger path.

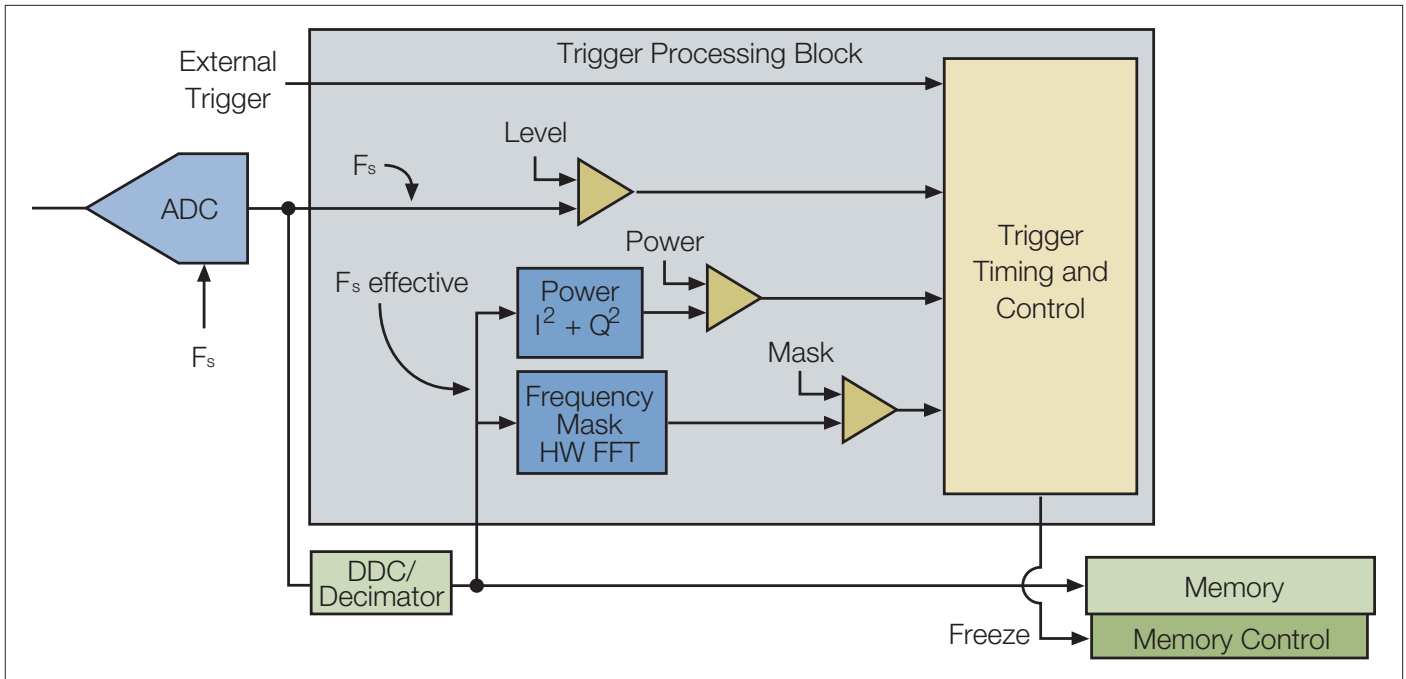

Figure 2-29. Real-Time Spectrum Analyzer trigger processing.

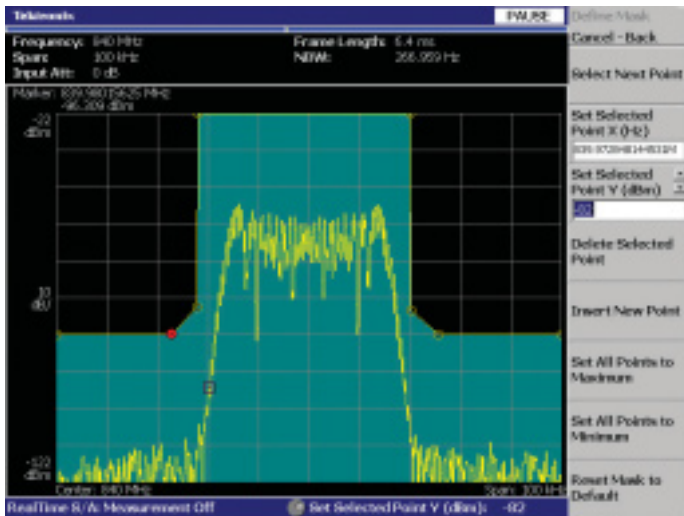

Figure 2-30. Frequency mask definition.

Frequency mask triggering compares the spectrum shape to a user-defined mask. This powerful technique allows changes in a spectrum shape to trigger an acquisition. FMTs can reliably detect signals far below full-scale even in the presence of other signals at much higher levels. This ability to trigger on weak signals in the presence of strong ones is critical for detecting intermittent signals, the presence of inter-modulation products, transient spectrum containment

violations and much more. A full DFT is required to compare a signal to a mask, requiring a complete frame. The time resolution for FMT is roughly one DFT frame. Trigger events are determined in the frequency domain using a dedicated hardware DFT processor, as shown in the block diagram in Figure 2-29.

Constructing a Frequency Mask

Like other forms of mask testing, the FMT (also known as frequency domain trigger) starts with a definition of an on-screen mask. This definition is done with a set of frequency points and their amplitudes. The mask can be defined point-by-point or graphically by drawing it with a mouse or other pointing device. Triggers can be set to occur when a signal outside the mask boundary “breaks in,” or when a signal inside the mask boundary “breaks out.”

Figure 2-30 shows a frequency mask defined to allow the passage of the normal spectrum of a signal but not momentary aberrations. On the next page, Figure 2-31 shows a spectrogram display for an acquisition that was triggered when the signal momentarily exceeded the mask. Figure 2-32 shows the spectrum for the first frame where the mask was exceeded. Note that pre-trigger and post-trigger data were collected and are both shown in the spectrogram.

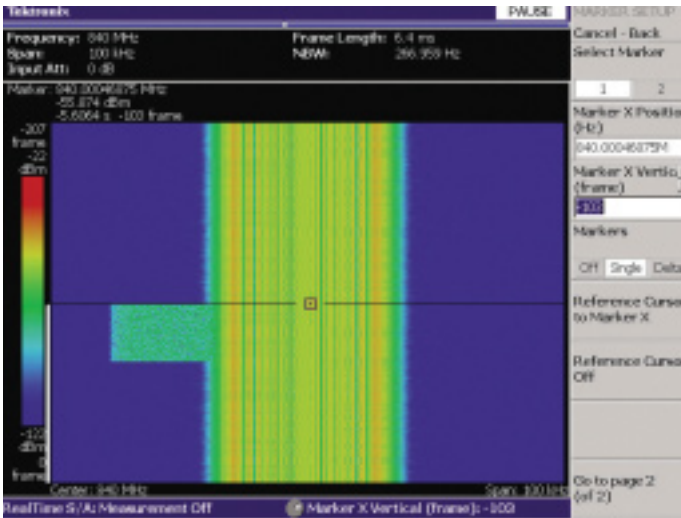

Figure 2-31. Spectrogram showing a transient signal adjacent to the carrier. The cursor is set to the trigger point, so pre-trigger data is displayed above the cursor line, and post-trigger data is displayed below the cursor line. The narrow white line at the left of the blue area denotes post-trigger data.

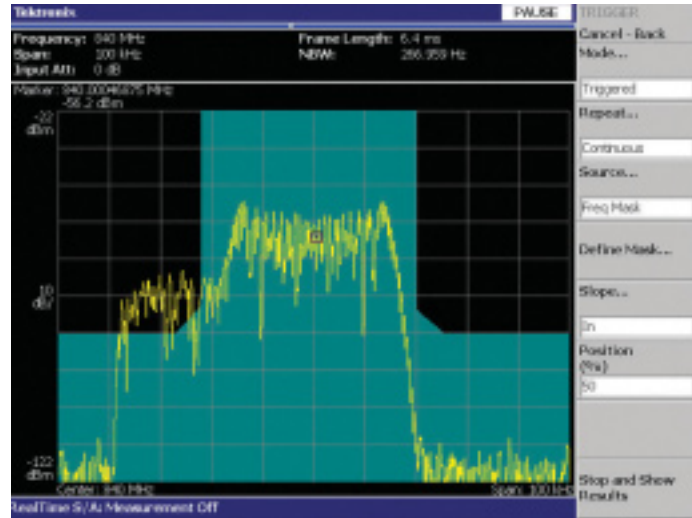

Figure 2-32. One frame of the spectrogram showing the trigger event where the transient signal breaks the boundary of the frequency mask.

Demodulation

Modulation is the means through which RF signals carry information. Modulation analysis using the Tektronix RTSA not only extracts the data being transmitted but also measures the accuracy with which signals are modulated. Moreover, it quantifies many of the errors and impairments that degrade modulation quality.

Modern communications systems have dramatically increased the number of modulation formats in use. The RTSA is capable of analyzing the most common formats and has an architecture that allows for the analysis of new formats as they emerge.

Amplitude, Frequency and Phase Modulation

RF carriers can transport information in many ways based on variations in the amplitude or phase of the carrier. Frequency

is the time derivative of phase. Frequency Modulation (FM) is therefore the time derivative of Phase Modulation (PM). Quadrature Phase Shift Keying (QPSK) is a digital modulation format in which the symbol decision points occur at multiples of 90 degrees of phase. Quadrature Amplitude Modulation (QAM) is a high-order modulation format in which both amplitude and phase are varied simultaneously to provide multiple states. Even highly complex modulation formats such as Orthogonal Frequency Division Multiplexing (OFDM) can be decomposed into magnitude and phase components.

Magnitude and phase can be thought of as the length and the angle of a vector in a polar coordinate system. The same point can be expressed in Cartesian or rectangular coordinates (X,Y). The IQ format of the time samples stored in memory by the RTSA are mathematically equivalent to Cartesian coordinates with I representing the horizontal or X component and Q the vertical or Y component.

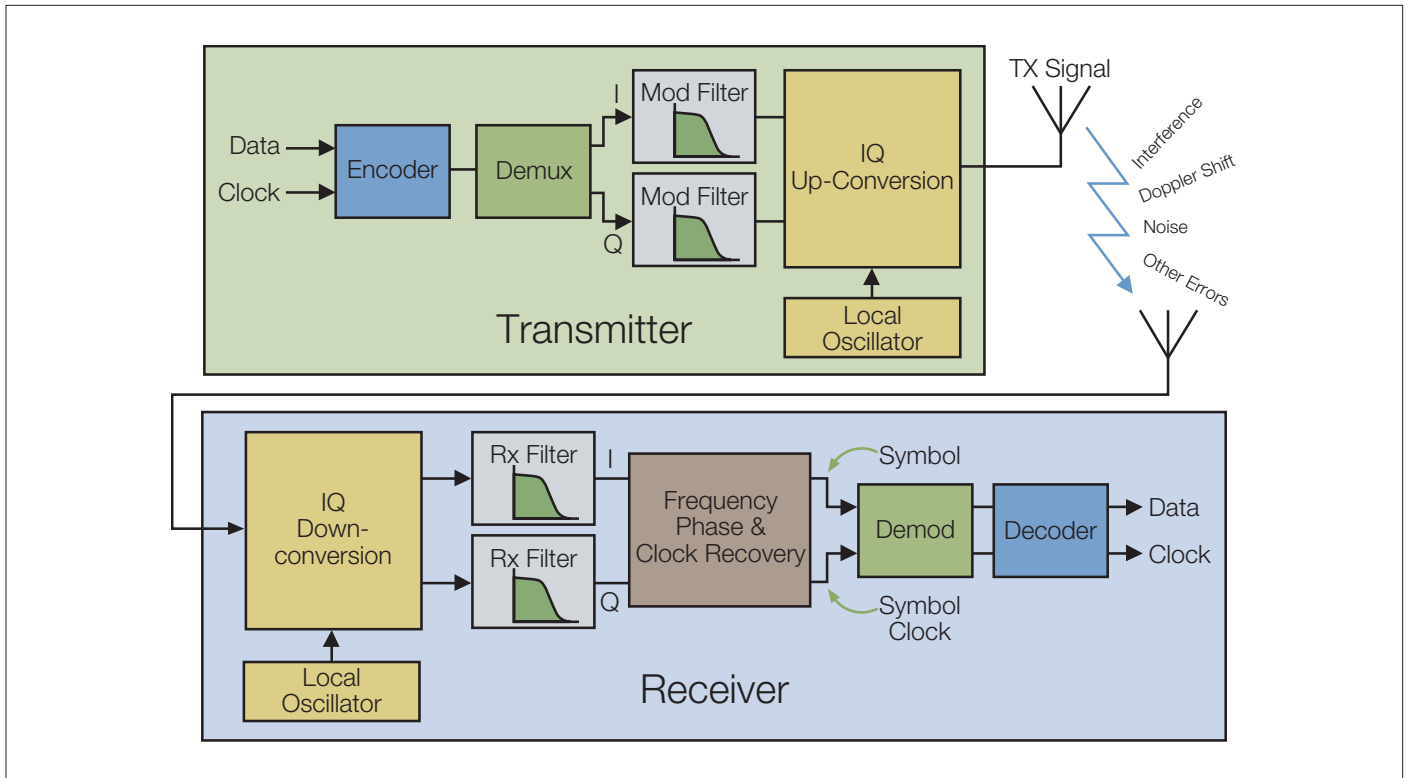

Figure 2-34. Typical digital communications system.

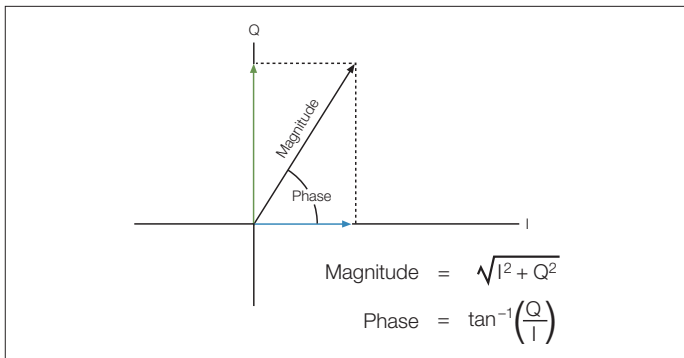

Figure 2-33. Vector representation of magnitude and phase.

Figure 2-33 illustrates the magnitude and phase of a vector along with its I and Q components. AM demodulation consists of computing the instantaneous magnitude for each IQ sample and plotting the result over time. PM demodulation consists of computing the phase angle of the IQ samples and plotting them over time after accounting for the discontinuities of the arctangent function at $\pm\pi/2$. FM is computed using the property that frequency is the time-derivative of phase. FM is the time-derivative of PM.

Digital Modulation

Figure 2-34 shows the signal processing in a typical digital communications system. The transmit process starts with the data to be sent and a clock. The data and clock are passed through an encoder that re-arranges the data, adds synchronization bits, and does encoding and scrambling which might be used in the receiver to recover errors that inevitable occur when signals are transmitted over the air. The data is then split into I and Q paths and filtered, changing it from bits to analog waveforms which are then up-converted to the appropriate channel and transmitted over the air.

The process of reception is the reverse of transmission with some additional steps. The RF signal is downconverted to I and Q baseband signals which are passed through Rx filters often designed to remove inter-symbol interference. The signal is then passed through an algorithm that recovers the exact frequency, phase and data clock. This is necessary to correct for multi-path delay and Doppler shift in the path and for the fact that the Rx and Tx local oscillators are not usually synchronized. Once frequency, phase and clock are recovered, the signal is demodulated and decoded, errors are corrected and bits lost due to signal degradation in the transmission path are recovered.

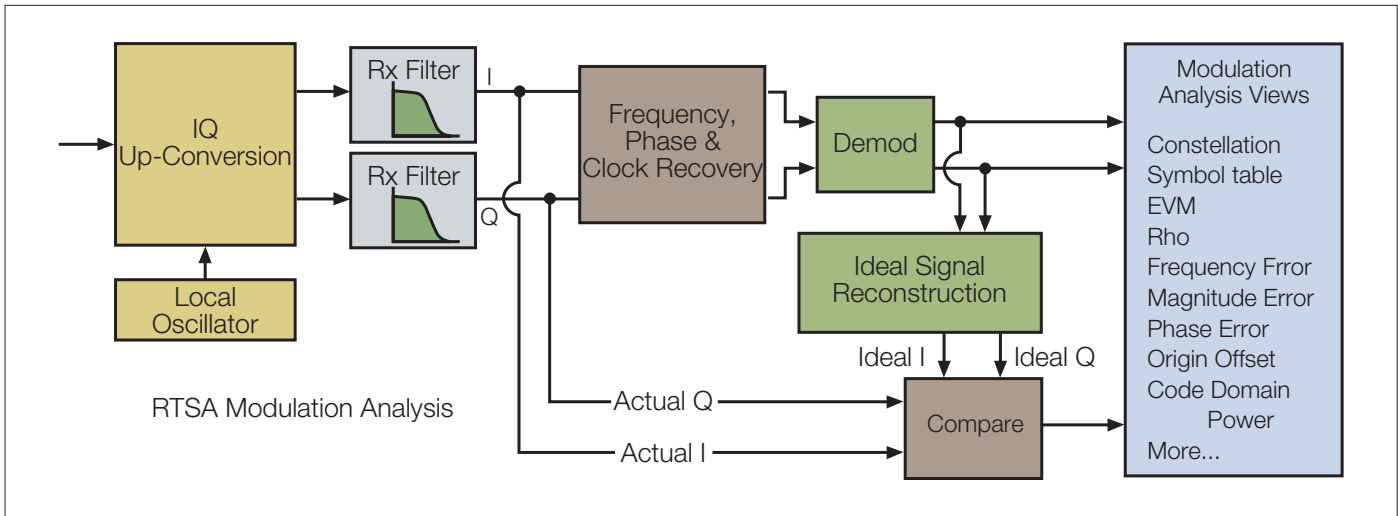

Figure 2-35. RTSA modulation analysis block diagram.

The varieties of digital modulation are numerous and include the familiar FSK, BPSK, QPSK, GMSK, QAM, OFDM and others. Digital modulation is often combined with channel assignments, filtering, power control, error correction and communications protocols to encompass a particular digital communication standard whose purpose is to transmit error-free bits of information between radios at opposite ends of a link. Much of the complexity incurred in a digital communication format is necessary to compensate for the errors and impairments that enter the system as the signal travels over the air or other media.

Figure 2-35 illustrates the signal processing steps required for a digital modulation analysis. The basic process is the same as that of a receiver except that modulation accuracy measurements require a comparison between the received and ideal modulation waveforms. The method used in most RTSA modulation quality measurements is to use the recovered symbols to reconstruct the mathematically ideal I and Q signals. These ideal signals are compared with the actual or degraded I and Q signals to generate the required modulation analysis views and measurements.

Power Measurements and Statistics

Tektronix RTSAs can perform power measurements both in the frequency domain and in the time domain. Time domain measurements are made by integrating the power in the I and Q baseband signals stored in memory over a specified time interval. Frequency domain measurements are made by integrating the power in the spectrum over a specified frequency interval. Channel filters, required for many standards-based measurements, may be applied to yield the resultant channel power. Calibration and normalization parameters are also applied to maintain accuracy under all specified conditions.

Communications standards often specify statistical measurements for components and end-user devices. RTSAs have measurement routines to calculate statistics such as the Complementary Cumulative Distribution Function (CCDF) of a signal which is often used to characterize the statistics including the Peak-Average Ratio (PAR) behavior of complex modulated signals.

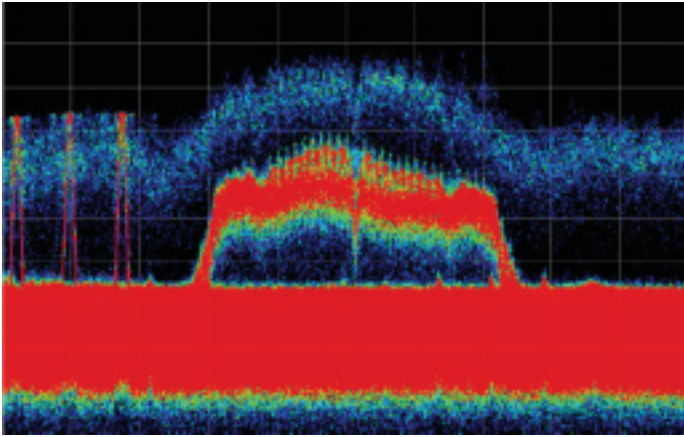

Figure 3-1. DPX Spectrum showing multiple signals occupying the same frequencies at different times.

Chapter 3: Real-Time Spectrum Analyzer Measurements

This chapter describes the operational modes and measurements of Real-Time Spectrum Analyzers (RTSA). Several pertinent details such as the sampling rates, the number of Discrete Fourier Transform (DFT) points, measurement analysis limits and sample limits are product dependent. Like the other measurement examples in this document, the information in this section applies specifically to the Tektronix RSA3000 Series and RSA6100 Series of RTSAs.

RTSA Measurement Types

Tektronix RTSAs can operate across the frequency, time, modulation and statistical domains. This section provides an overview of the measurements available in the various RTSA models.

Frequency Domain Measurements

The basic frequency domain measurements described in this chapter are the Live RF Digital Phosphor Display (DPX) Spectrum Display measurements, the Spectrum Display measurements, and the Spectrogram Display measurement capability.

DPX Spectrum

The DPX Spectrum measurement is the key to the RTSA's ability to discover elusive signals that are missed by other analyzers. The key performance parameter for DPX technology in all Tektronix RTSAs is minimum duration for a 100% Probability of Intercept (POI) of a single event. This

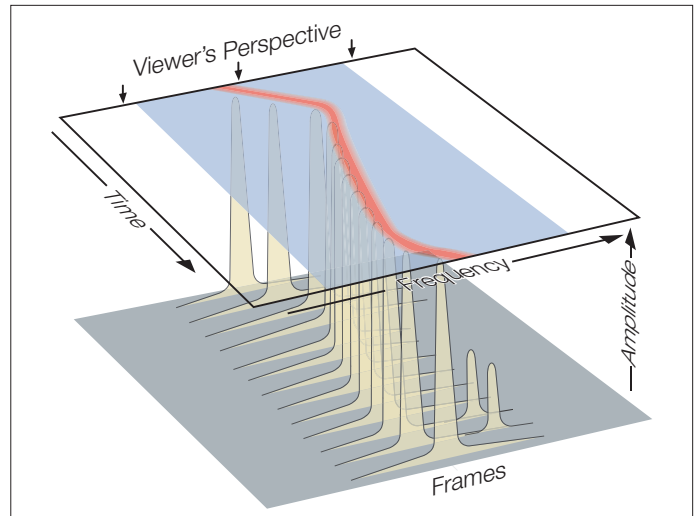

Figure 3-2. Spectrogram display.

basic figure of merit for signal discovery can be as brief as 24 μ sec in the RSA6100. DPX spectrum also provides a true representation of multiple signals occupying the same frequencies at different times as shown in Figure 3-1.

DPX spectrum provides a Live RF display, allowing the user to see fleeting signals dramatically reducing the time required to discover and resolve problems. DPX spectrum operates continuously in free-run mode. It does not use triggers and is independent of acquisition memory.

Spectrum and Spectrogram Measurements

Both the spectrum and spectrogram measurements are based on DFT analysis of data that is stored in memory. These measurements can run either triggered or in free run mode. Spectrum and spectrogram measurements are displayed separately in all RTSAs. They are treated together here because both measurements operate on the same acquired data and are linked in both time and frequency by markers.

As shown in Figure 3-2, the spectrogram display is an important measurement that provides an intuitive display of how frequency and amplitude behavior change over time. Like the spectrum display, the horizontal axis shows the frequency range of the span. In the spectrogram, though the vertical axis represents time, and amplitude is represented by the color of the trace. Each "slice" of the spectrogram corresponds to a single frequency spectrum calculated from one spectrum length of data.

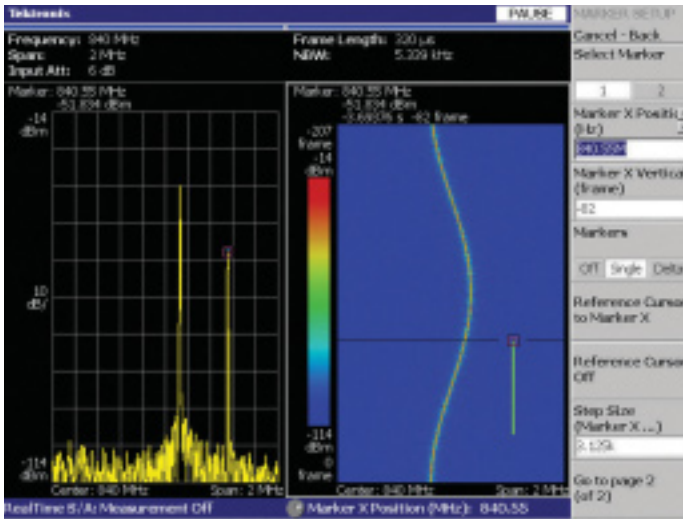

Figure 3-3. Time-correlated views: Power vs. Frequency display (left) and spectrogram display (right).

Figure 3-3 shows a screen shot displaying the spectrum and spectrogram displays for the signal illustrated in Figure 3-2. On the spectrogram, the oldest frame is shown at the top of the display. This measurement shows an RF signal whose frequency is changing over time, and it also reveals a low-level transient signal that appears and disappears near the end of the time block. Since the data is stored in memory, a marker can be used to scroll “back in time” through the spectrogram. In Figure 3-3, a marker has been placed on the transient event on the spectrogram display, which causes the corresponding spectrum display to be shown at that particular point in time.

Spectrum Measurements Beyond the Real-Time Bandwidth
As shown in Figure 3-4, RTSA provides frequency domain measurements that emulate a traditional Swept Spectrum Analyzer (SA). For frequency spans that exceed the real-time bandwidth of the instrument, this is achieved by tuning the RTSA across the span of interest much like a traditional spectrum analyzer and successive spectrum acquisitions are taken before tuning to the next step. DPX spectrum, real-time triggers and real-time seamless capture are not available when spectrum measurements are set beyond the real-time bandwidth (or when in standard SA mode on the RSA3000 Series).

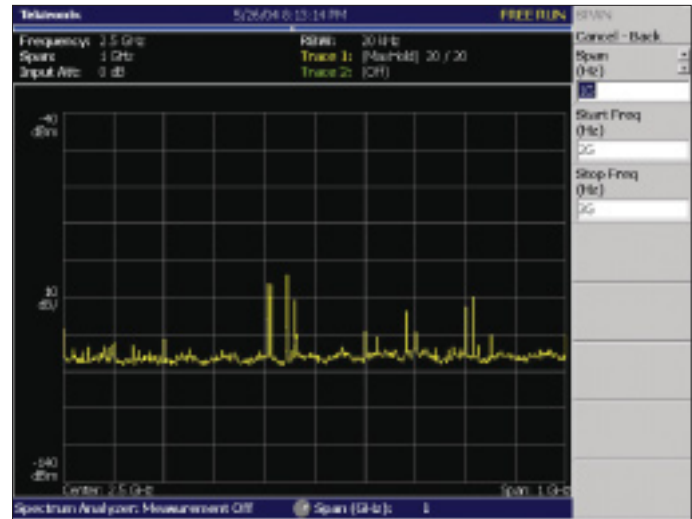

Figure 3-4. Standard SA mode showing an off-the-air measurement over a 1 GHz frequency span using maxhold.

Time Domain Measurements

Frequency vs. Time

The Frequency vs. Time measurement displays frequency on the vertical axis and time on the horizontal axis. While the spectrogram display can show the same information, Frequency vs. Time has two important differences. First, the Frequency vs. Time view has much better time domain resolution than the spectrogram, as described in detail below. Second, this measurement calculates a single frequency value for every point in time, which means that it cannot display multiple RF signals like the spectrogram can.

The spectrogram is a compilation of DFT results and has a line-by-line time resolution equal to the length of one DFT frame. The Frequency vs. Time view has a time resolution of one sample interval. If 1024 time domain samples were used in a calculating a spectrum, the resolution in this mode is 1024 times finer than that of the spectrogram. This makes it easy to see small, brief frequency shifts in great detail. The view acts similar to a frequency discriminator or a frequency counter. Each of the sample points represents a frequency value, whether the span is a few hundred hertz or many megahertz. Constant-frequency signals such as CW or AM produce a flat, level display.

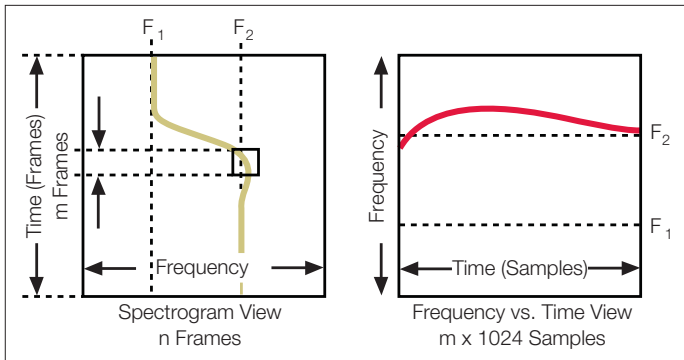

Figure 3-5. Comparison of spectrogram and Frequency vs. Time.

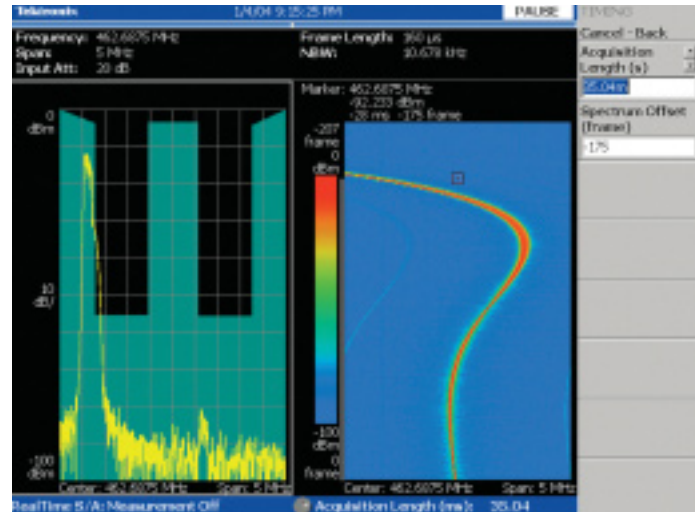

Figure 3-6. Spectrogram view of frequency settling over 5 MHz of frequency and 35 ms of time.

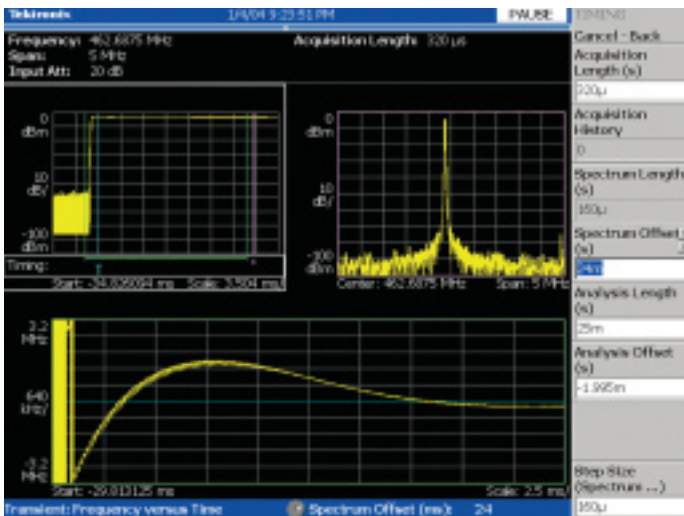

Figure 3-7. Frequency vs. Time view of frequency settling over 5 MHz of frequency and 25 ms of time.

The Frequency vs. Time view provides the best results when there is a relatively strong signal at one unique frequency. Figure 3-5 is a simplified illustration contrasting the Frequency vs. Time display with a spectrogram. The Frequency vs. Time display is in some ways a zoomed-in view that magnifies a portion of the spectrogram. This is very useful for examining transient events such as frequency overshoot or ringing. When there are multiple signals in the measured environment, or one signal with an elevated noise level or intermittent spurs, the spectrogram remains the preferred view. It provides visualization of all the frequency and amplitude activity across the chosen span.

Figures 3-6, 3-7, and 3-8 show three different analysis views of the same acquisition. As shown in Figure 3-6, the frequency mask trigger (FMT) was used to capture a transient signal coming from a transmitter having occasional problems with frequency stability during turn-on. Since the oscillator was not tuned to the frequency at the center of the screen, the RF signal broke the frequency mask shown on the left and caused a trigger. The spectrogram plot on the right shows the frequency settling behavior of the device.

The next two figures show Frequency vs. Time displays of the same signal. Figure 3-7 shows the same frequency settling behavior as the spectrogram using a 25 ms analysis length. Figure 3-8 shows the ability to zoom in to an analysis length of 1 ms, showing the changes in frequency over time with much finer time domain resolution. This reveals a residual oscillation on the signal even after it has settled to the correct frequency.

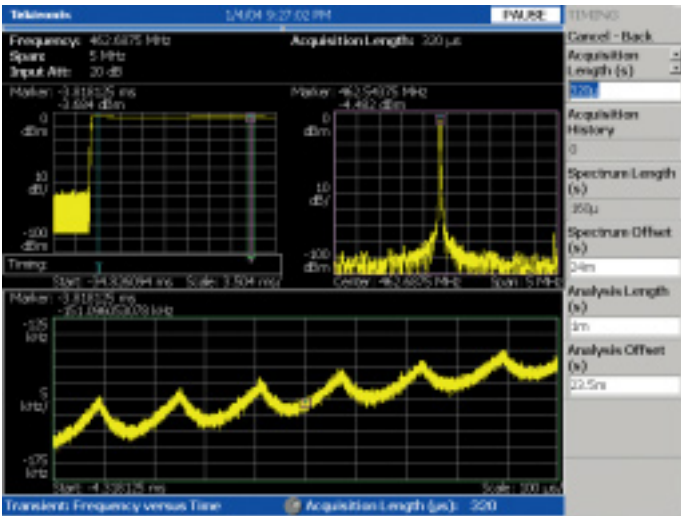

Figure 3-8. Zooming in to view frequency settling over 50 kHz of frequency and 1 ms of time.

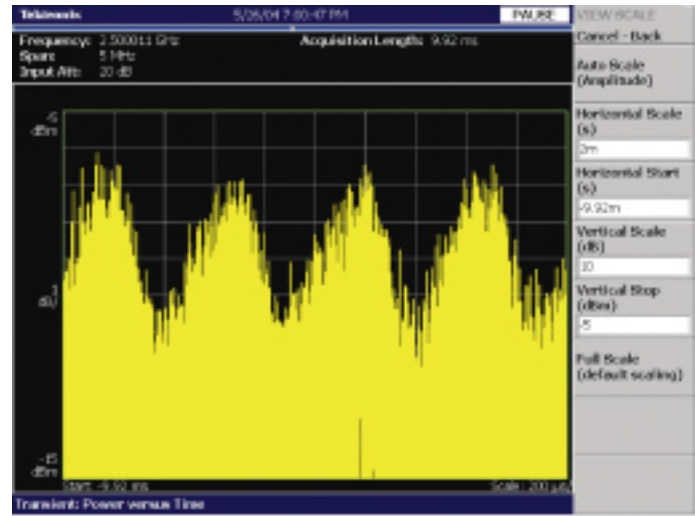

Figure 3-9. Power vs. Time display.

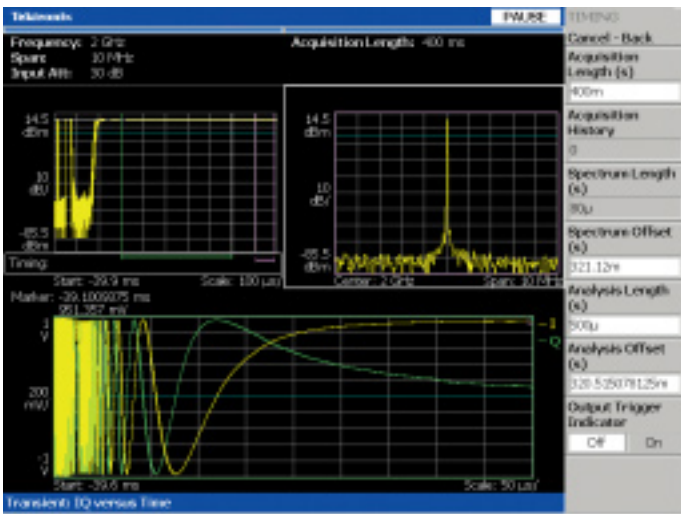

Figure 3-10. IQ vs. Time measurement of settling transient.

Amplitude or Power vs. Time

The Power vs. Time display (Figure 3-9) shows how the power of a signal changes on a sample by sample basis. The amplitude of the signal is plotted in dBm on a logarithmic scale. This display is similar to an oscilloscope's time domain view in that the horizontal axis represents time. In contrast, the vertical axis shows power on a log scale instead of voltage on a linear scale. On the RSA3000 Series Spectrum analyzers, the trace represents the total power detected within the span. The RSA6100 Series Spectrum analyzers offer the choice of a user-selectable filter in addition to the full span bandwidth. A constant power signal will yield a flat trace display since there is no power change as time advances.

For each time domain sample point, power is calculated as follows:

$$Power = 10 * \log\left(\frac{I^2 + Q^2}{1 \text{ mW}}\right)$$

The Power vs. Time display is also available in the Time Overview display. The Time Overview display shows the RF amplitude in the full acquisition bandwidth for the entire acquisition while the Power vs. Time display shows the time segment defined by the analysis offset and analysis length displays.

Phase vs. Time

The Phase vs. Time is similar in concept to Power vs. Time. The phase value for each IQ pair is computed and the result is displayed as a function of time. The phase at each IQ sample is computed as follows:

$$Phase = \tan^{-1}\left(\frac{Q}{I}\right) * \frac{180}{\pi} \text{ Degrees}$$

IQ vs. Time

Transient IQ vs. Time (Figure 3-10) is another time domain view that displays the amplitudes of I and Q as a function of time. This measurement shows the raw I and Q output signals coming from the digital downconverter. As a result, this display is not synchronized to any modulation that might be present on the signal being analyzed. Some of the digital demodulation measurements can also show IQ vs. Time after synchronization.

This measurement can be another useful troubleshooting tool for expert users, especially in terms of lending insight into frequency and phase errors and instabilities.

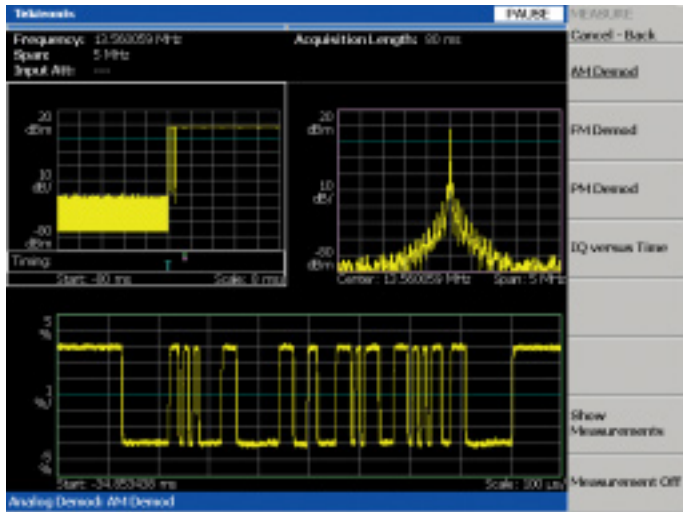

Figure 3-11. AM demodulation analysis of a pulsed signal using amplitude shift keying to encode data.

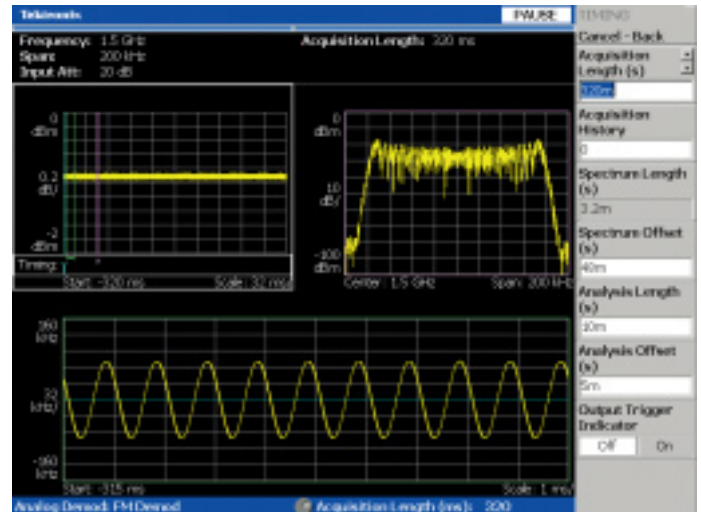

Figure 3-12. FM demodulation analysis of a signal being modulated by a sine wave.

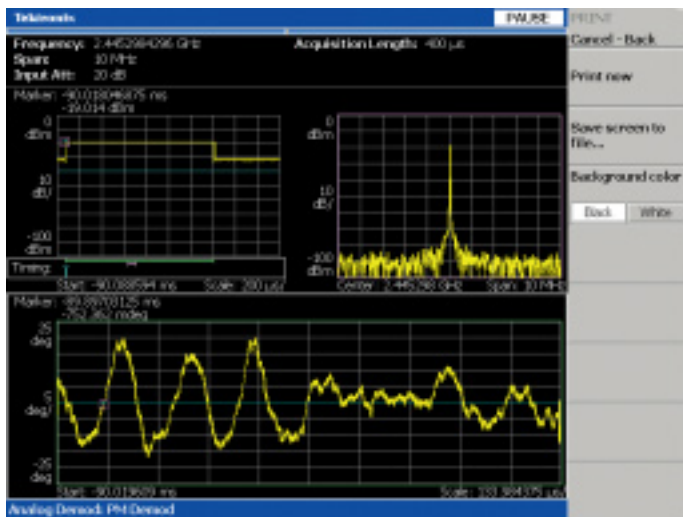

Figure 3-13. PM demodulation analysis showing phase instability over a long burst.

Modulation Domain Measurements

Analog Modulation Analysis

The analog demodulation mode provides measurements to demodulate and analyze amplitude modulation (Figure 3-11), frequency modulation (Figure 3-12), and phase modulation (Figure 3-13). Just like the time domain measurements, these tools are based on the concept of multi-domain analysis, and the spectrum and analysis windows can be positioned anywhere within the block shown in the Time Overview window.

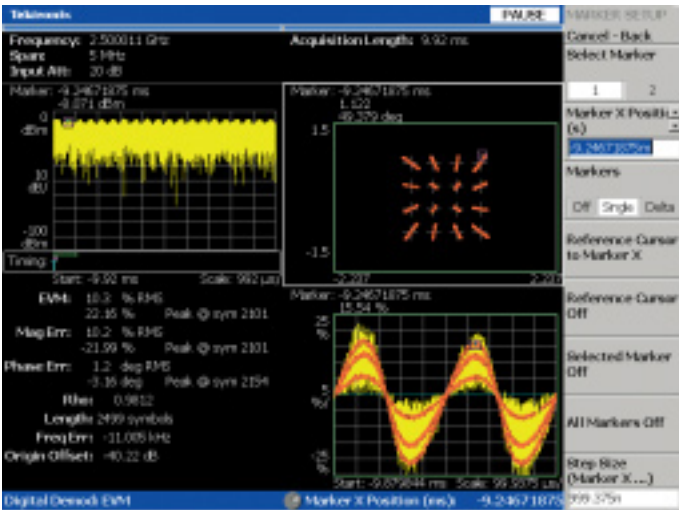

Figure 3-14. EVM analysis over time of 16 QAM signal reveals sinusoidal amplitude distortion displayed in EVM vs. time result in lower right quadrant.

Digital Modulation Analysis

The digital modulation analysis function can demodulate and analyze many common digital signals based on phase shift keying (PSK), frequency shift keying (FSK), and Quadrature Amplitude Modulation (QAM). The RTSA provides a wide range of measurements including: constellation, error-vector magnitude (EVM), magnitude error, phase error, demodulated IQ vs. time, symbol table, and eye diagram. To make these measurements, it is necessary to properly configure variables such as the modulation type, symbol rate, measurement (receive) filter type and parameter such as roll-off factor of a root-raised cosine filter, and reference filter type.

The RTSA provides a powerful solution for characterizing dynamic modulated signals by combining the digital demodulation measurements of a Vector Signal Analyzer (VSA) with real-time triggering and time-correlated multi-domain analysis, as illustrated in Figures 3-14, 3-15, and 3-16.

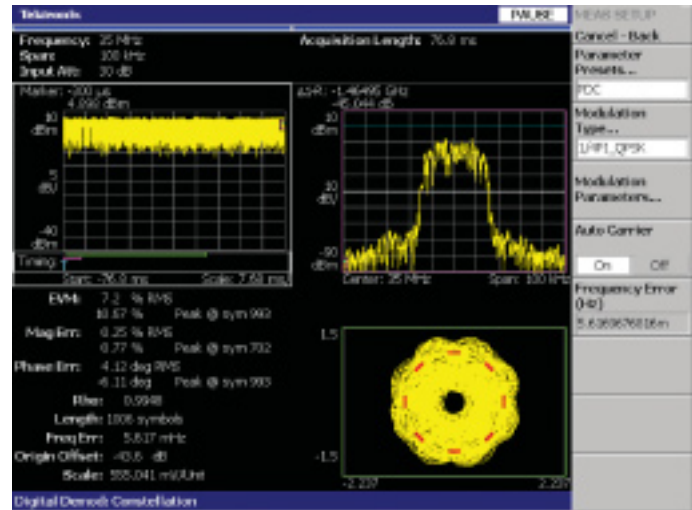

Figure 3-15. Constellation display showing phase instability in a PDC signal. Lower right hand quadrant shows slewed symbol timing at constant amplitude representing phase instability.

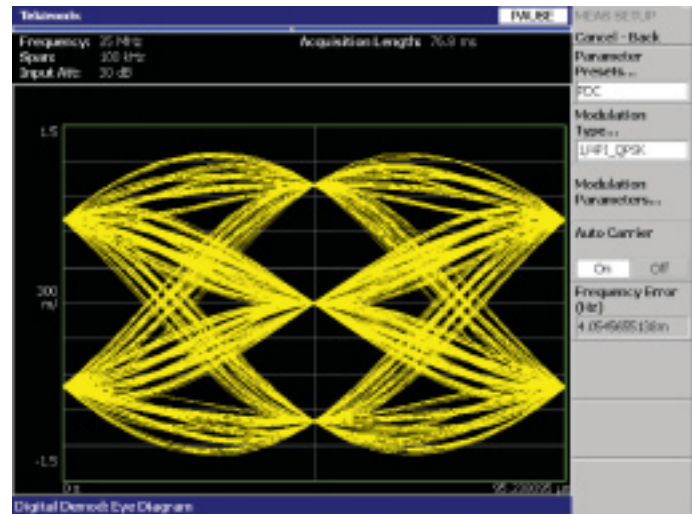

Figure 3-16. Eye diagram display showing a PDC signal.

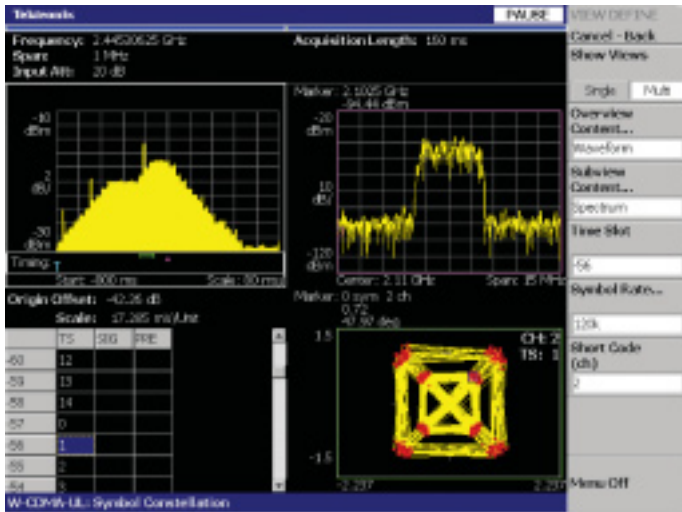

Figure 3-17. Modulation analysis of a W-CDMA handset under closed-loop power control. The constellation display (lower right) shows the error associated with large glitches that occur during level transitions, which can be seen in the Power vs. Time display.

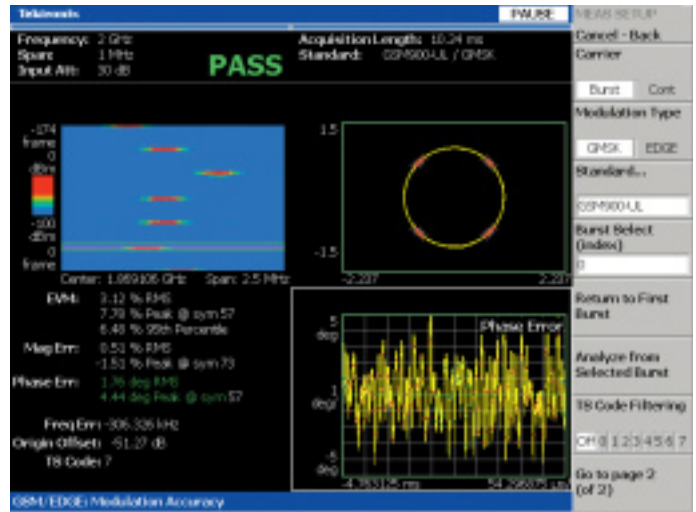

Figure 3-18. Spectrogram, constellation, EVM, and phase error vs. time of frequency-hopping GSM signal.

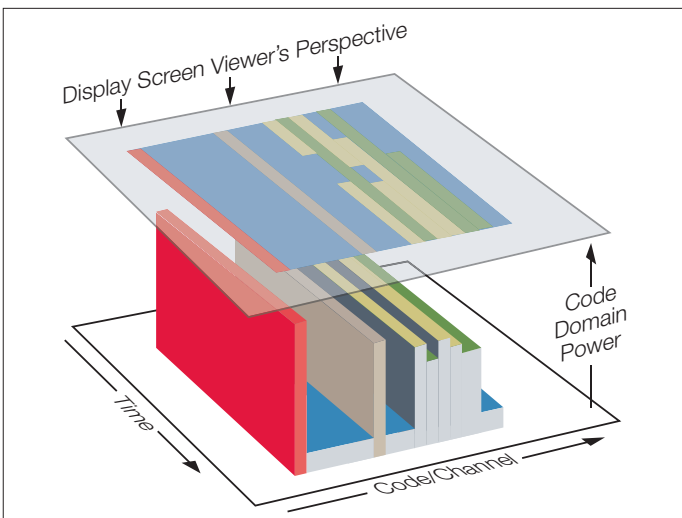

Figure 3-19. Illustration of the codogram display.



Figure 3-20. Codogram measurement of W-CDMA compressed mode.

Standards-based Modulation Analysis

The RTSA also provides solutions for modulation analysis of many communications standards such as W-CDMA, HSDPA/HSUPA, GSM/EDGE, CDMA2000, 1xEV-DO, Zigbee, WiMax, WLAN (IEEE 802.11 a/b/g/n) and more. Figures 3-17 and 3-18 show examples of standards-based modulation analysis.

Code Domain Measurements

Codogram Display

The codogram display (Figure 3-19) of the RTSA adds a time axis to code domain power measurements for CDMA-based communications standards. Like the spectrogram, the codogram intuitively shows changes over time.

Figure 3-20 is a W-CDMA codogram display from an RTSA. This particular codogram shows a simulated W-CDMA compressed mode handoff in which the data rate is momentarily increased to make room for brief, temporary gaps in the transmission. These gaps allow dual-mode W-CDMA/GSM user equipment to search for an available GSM base station while remaining connected to a W-CDMA Node B.

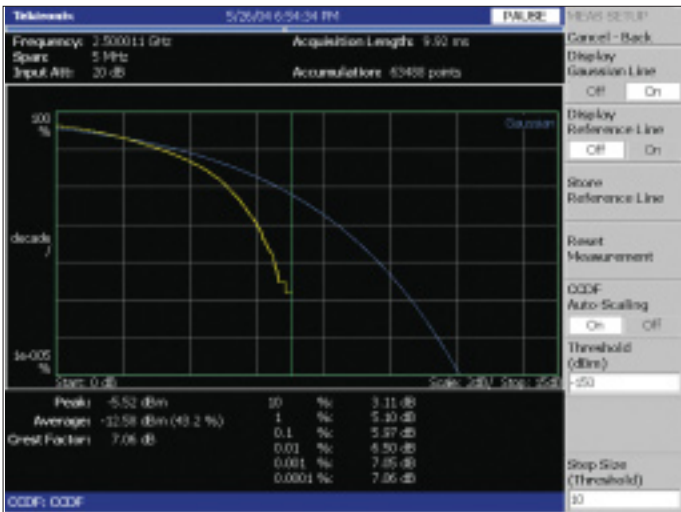

Figure 3-21. CCDF measurement.

Statistical Domain Measurements

Complementary Cumulative Distribution Function

The Complementary Cumulative Distribution Function (CCDF) view displays the probability that the signal power above average power on the measured signal exceeds the amplitude displayed on the horizontal scale. The horizontal axis is scaled in dB above average signal power. Probability is displayed as a percent on the vertical scale. The vertical axis is logarithmic.

CCDF analysis can be used to measure the time-varying crest factor, which is important for many digital signals, especially those that use CDMA and OFDM. The crest factor is the ratio of a signal's peak power divided by its average power, with the result expressed in dB:

$$C = 10 \log \left(\frac{P_{peak}}{P_{average}} \right) = 20 \log \left(\frac{V_{peak}}{V_{rms}} \right)$$

The crest factor of the signal determines how linear a transmitter or receiver must be in order to avoid unacceptable levels of signal distortion. In Figure 3-21, the CCDF curves show the measured signal in yellow and a Gaussian reference trace in blue. The CCDF and crest factor are especially interesting to designers who must balance power consumption and distortion performance of devices such as amplifiers. When CCDF is used over a selected period of a waveform and compared to measures of distortion such as ACP, the user can determine how statistical variations in the signal create distortions in an amplifier output.

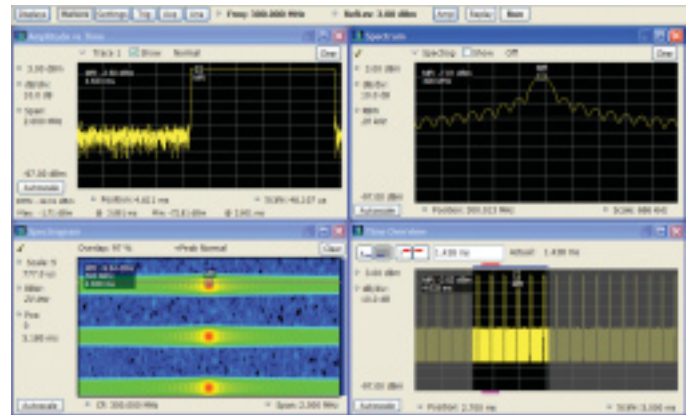

Figure 3-22. The marker on each display above represents the same point in time in the acquisition memory.

Time-Correlated Multi-Domain Analysis

Once a signal has been acquired and stored in memory, it can be analyzed using the wide variety of time-correlated views available in the RTSA, as illustrated in Figure 3-21.

This is especially useful for device troubleshooting and signal characterization applications. All of these measurements are based on the same underlying set of time domain sample data, which underscores two significant architectural advantages:

- Comprehensive signal analysis in the frequency, time, and modulation domains based on a single acquisition.
- Domain correlation to understand how specific events in the frequency, time, and modulation domains are related based on a common time reference.

Spectrum and Spectrogram

The RTSA provides two views that are correlated in both time and frequency, the spectrum display and the spectrogram display. These two views can be seen in Figure 3-22, together with the time overview and Amplitude vs. Time analysis. In each display, the marker on screen corresponds to the same point within the acquisition memory.

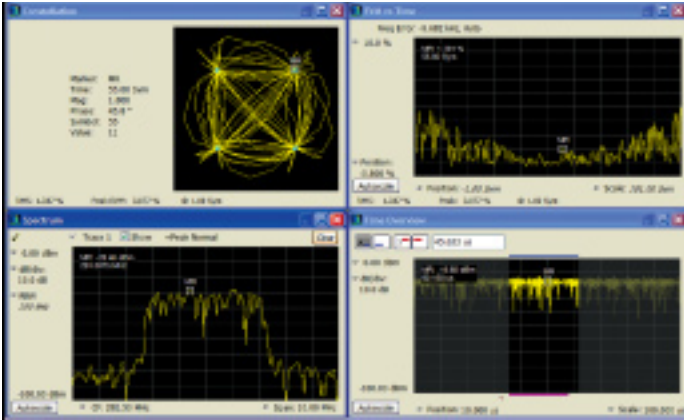

Figure 3-23. Time Overview, EVM vs. Time, Constellation and Spectrum with time-correlated markers.

Correlating Modulation and Time Domain Results

In the other real-time measurement modes for time domain analysis and modulation domain analysis, the RTSAs shows multiple views of the captured signal as illustrated in Figure 3-23.

The window in the lower right in Figure 3-23 displays Time Overview (Power vs. Time) for the entire acquisition. This overview shows all of the data that was acquired in the block, and it serves as the index for the other analysis windows.

The window in the upper right in Figure 3-24 shows the spectrum or Power vs. Frequency for one frame of the spectrogram shown on the upper left. Just like the display in Figure 3-23, this is the spectrum of one frame of data, and it is possible to scroll through the entire time record to see the spectrum at any point in time. This is done by adjusting the spectrum offset. Also note that there is a purple bar in the spectrogram window that indicates position in time that corresponds to the frequency domain display in the spectrum window.

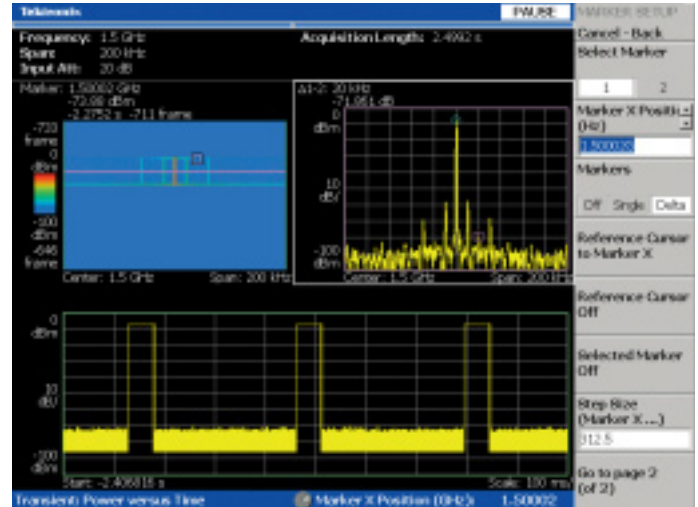

Figure 3-24. Multi-domain view showing Spectrogram, power vs. frequency, and power vs. time.

The window in the bottom half of the screen (outlined in green) displays the results of the selected time or modulation analysis measurement.

Figure 3-23 shows an example of frequency modulation analysis, and Figure 3-24 shows an example of transient Power vs. Time analysis. The green analysis window can be positioned anywhere within the time record shown in the Time Overview, which has corresponding green bars to indicate its position. In addition, the width and position of the analysis window can be adjusted using the analysis length and analysis offset controls.

Chapter 4: Applications Using the Real-Time Spectrum Analyzer

Pulse Measurements

Tektronix Real-Time Spectrum Analyzers (RTSAs) are ideally suited for making pulse measurements. Automatic pulse measurement software can be included on all models of RTSA. Extensive analysis on individual and pulse trend information can be selected. Unlike traditional spectrum analyzers, the various models of RTSA are specified for system rise-time/falltime (to 10 ns), minimum pulse duration (as short as 50 ns), and modulation bandwidths to 110 MHz. For faster risetimes, pulses, and wider modulation bandwidths, the RTSA off-line software can be used in conjunction with Tektronix DPO70000 and DSA70000 Series oscilloscopes for automatic pulse measurements in the 10s of picoseconds and bandwidths up to 20 GHz.

Individual pulse information for carrier frequency, risetime, falltime, droop, ripple, occupied spectrum, and pulsewidth are among the many pulse measurements that can be selected and characterized on the pulse measurement analysis software.

Pulse trend statistics information includes PRF, duty cycle, and pulse-to-pulse phase information. In addition, on the RSA6100 Series, statistical information can be displayed as a trend, or Fast Fourier Transforms (FFTs) can be performed over the sampled data to reveal important diagnostic information.

Radar

Integration of pulse measurements into a single tool for time and frequency domain simplifies radar testing and improves test reproducibility. The RTSA has the combined test capability that replaces several common tools used in radar transmitter test analysis (oscilloscopes, spectrum analyzers, vector analyzers, power meters, and peak-power meters). In addition, the Digital Phosphor Display (DPX) can display interference components and the products nonlinearities that go undetected with other tools.

There are several application notes and white papers available from Tektronix on using the RTSA to test radars:

- 37W-20229 Advanced Radar Testing with the Real-Time Spectrum Analyzer
- 37W-19190 Radar Pulse Measurements with the Real-Time Spectrum Analyzer

For the latest information on radar test solutions from Tektronix, visit the web: <http://www.tektronix.com/radar>

RFID

RFID systems are used for a variety of applications: Near-Field Communications (NFC) for transaction information on cellular telephones; recently mandated Tire Pressure Monitoring Systems (TPMS) for vehicle safety; Real-Time Location Systems (RTLS) for the tracking of goods, and even the asset tracking systems for commercial goods, with the ePC Global initiatives. RFID systems operate over a wide range of frequencies from HF frequencies (135 kHz) to microwave (2.4 GHz) and at various power levels for both passive and active modes. However, as many RFID systems also operate in the unlicensed Industrial Scientific and Medical (ISM) bands, these systems become susceptible to collisions of other RFID systems and communications operating in the same bands.

The ability to automate pulse measurements is important for designing to the function of all RFID systems. The RTSAs have the most comprehensive support of industry, international, and proprietary RFID standards. Tag and reader/interrogator performance and interaction can be completely analyzed with quick, easy, and repeatable measurement setups and deep memory capture

There are several application notes and white papers available from Tektronix on using the RTSA to test RFID systems:

- 37W-19258 RFID and NFC Measurements with the Real-Time Spectrum Analyzer
- 37W-18055 Radio Frequency Identification (RFID) Overview
- 37W-17155 Evaluating and Optimizing RFID Systems Using the RTSA

For the latest information on RFID testing solutions from Tektronix, visit the web: <http://www.tektronix.com/rfid>

Spectrum Management/Surveillance

Whether you are securing a facility or protecting your spectrum investment, interference must be mitigated. The detection of low-level and intermittent interference in the presence of larger signals and the characterization of impulsive noise are not possible with any certainty using most spectrum analyzer tools.

With DPX displaying Live RF, you will see signals you never knew existed. RTSAs will change the way you search and discover elusive signals. With industry-leading performance for combined bandwidth and dynamic range, RTSAs are the only spectrum analyzers specified with a 100% probability of detecting signals within a band of interest.

Frequency Mask Trigger (FMT) enables the RTSA to trigger on low-level signals or impulses with a 100% probability for capture and analysis.

There are several application notes and white papers available from Tektronix on using the RTSA in spectrum management and surveillance applications:

- 37W-20120 Advanced Spectrum Management using the Real-Time Spectrum Analyzer
- 37W-18576 Signal Monitoring and Surveillance using the RTSA

For the latest information on spectrum management and surveillance solutions from Tektronix, visit the web:
<http://www.tektronix.com/surveillance>

Radio Communications

More and more of the control and operation of modern radio communications are controlled by software. Digital circuits are replacing analog functions for dynamic operation of modulation, power, channel control, and channel loading. These modern radios can change power, frequency, modulation, coding, and statistics rapidly over time.

By eliminating the need to switch modes between time and frequency analysis, RTSAs have the ability to time-correlate capture data and analyze in the multi-domains of time, frequency, modulation, code, and statistics. Capture your data once, and analyze completely.

The combination of DPX Spectrum and FMT provide a powerful and unique capability for Radio Debug. DPX can discover unusual transient events such as impulse noise caused by software faults or other low-level spectrum noise while the FMT can be set up to isolate those events. Using the external trigger output in conjunction with the FMT allows you to trigger other instruments. Triggering oscilloscopes and logic analyzers enables you to isolate events deep into your block diagram so that the root cause can be isolated. Tektronix iView capability and Mixed-Signal Oscilloscopes allow for the accurate time alignment and display of analog and digital signals to with picosecond accuracy. Subroutines and lines of code can be time correlated to the actual spectrum event of interest.

There are several application notes and white papers available from Tektronix on using the RTSA for radio communications applications:

- 37W-18369 Software Defined Radio: Integrated Method for Designing SCA compliant radios
- 37W-19680 Software Defined Radio Testing Using the Real-Time Spectrum Analyzers
- 37W-19295 RTSA Baseband Measurements White Paper

For more information on Tektronix solutions for radio communications and radio debug solutions, visit the web:
<http://www.tektronix.com/radiocomms>

Power Amplifier Testing

Voice communications in mobile communications tend to operate at some level of steady traffic state. As high rate data services become integrated into modern radio communication standards, (HSDPA/HSUPA, 1xEV, WiMax), the output power needs to be rapidly adapt to the changing load. Modulation quality, spectral regrowth, and power efficiency are a constant trade-off in amplifier design.

Whether advances in linearization are drive by the need for better efficiency, reduced cost, or performance, various digital techniques using some for of adaptive digital predistortion (DPD) have become common in cellular amplifier design. These designs are susceptible to memory effects, bias feed through, and other transient spectral regrowth abnormalities.

With the ability to reveal the existence of memory effects using DPX Spectrum, the RTSA can provide unique insight for amplifier designers. Add the capability of correlated multi-domain analysis for amplitude statistics (CCDF), modulation quality (EVM), and Adjacent Channel Power (ACP) analysis, and the RTSAs provides invaluable insight for amplifier designers.

Learn more about the characterization of modern amplifiers with the application note:

- 37W-19560 Troubleshooting and Characterizing Wide Band RF Systems Using the Real-Time Spectrum Analyzers

Microphonics and Phase-Hits Analysis

Microphonics and phase-hit problems have a reputation for disrupting development programs and stopping production lines. As more of today's modern communications systems and electronics have become portable, these systems have become very sensitive to these unintentional, internally generated sources of modulation. Compounding the problem, the intermittent nature of these disturbances has traditionally made the detection and isolation of these events difficult and time consuming.

The Real-Time Spectrum Analyzers have unique ability to display the presence of these events with certainty using DPX spectrum display at >48,000 spectrum updates per second. Isolation, characterization, measurement, and correlation to root cause can be simplified using a combination of the unique Frequency Mask Trigger and External Trigger output on the Real-Time Spectrum Analyzers.

Learn more about the phenomena and how to capture and measure microphonics and phase-hits with the application note:

- 37W-18577 Capturing and Measuring Microphonics and Phase-Hits with the Real-Time Spectrum Analyzers

Chapter 5: Terminology

Glossary

Acquisition - An integer number of time-contiguous samples.

Acquisition Time - The length of time represented by one acquisition.

Amplitude - The magnitude of an electrical signal.

Amplitude Modulation (AM) - The process in which the amplitude of a sine wave (the carrier) is varied in accordance with the instantaneous voltage of a second electrical signal (the modulating signal).

Analysis Time - A subset of time-contiguous samples from one block, used as input to an analysis view.

Analysis View - The flexible window used to display real-time measurement results.

Carrier - The RF signal upon which modulation resides.

Carrier Frequency - The frequency of the CW component of the carrier signal.

Center Frequency - The frequency corresponding to the center of a frequency span of a spectrum the analyzer display.

CZT-Chirp-Z transform - A computationally efficient method of computing a Discrete Fourier Transform (DFT). CZTs offer more flexibility for example in selecting the number of output frequency points than the conventional FFT at the expense of additional computations.

Codogram - Code Channel vs. Time vs. Power display where the CDMA code channel is represented on x-axis and time respectively on the y-axis. The power level is expressed by the color.

CW Signal - Continuous wave signal. A sine wave.

dBfs - A unit to express power level in decibels referenced to full scale. Depending on the context, this is either the full scale of the display screen or the full scale of the ADC.

dBm - A unit to express power level in decibels referenced to 1 milliwatt.

dBmV - A unit to express voltage levels in decibels referenced to 1 millivolt.

Decibel (dB) - Ten times the logarithm of the ratio of one electrical power to another.

DFT-Discrete Fourier transform - A mathematical process to calculate the frequency spectrum of a sampled time domain signal.

Display Line - A horizontal or vertical line on a waveform display, used as a reference for visual (or automatic) comparison with a given level, time, or frequency.

Distortion - Degradation of a signal, often a result of nonlinear operations, resulting in unwanted frequency components. Harmonic and intermodulation distortions are common types.

DPX - Digital Phosphor analysis - A signal analysis and compression methodology that allows the live view of time-changing signals allowing the discovery of rare transient events.

DPX Spectrum - DPX technology applied to spectrum analysis. DPX Spectrum provides a Live RF view as well as the observation frequency domain transients.

Dynamic Range - The maximum ratio of the levels of two signals simultaneously present at the input which can be measured to a specified accuracy.

FFT - Fast Fourier Transform - A computationally efficient method of computing a Discrete Fourier Transform (DFT). A common FFT algorithm requires that the number of input and output samples are equal and a power of 2 (2,4,8,16,...).

Frequency - The rate at which a signal oscillates, expressed as hertz or number of cycles per second.

Frequency Domain View - The representation of the power of the spectral components of a signal as a function of frequency; the spectrum of the signal.

Frequency Drift - Gradual shift or change a signal frequency over the specified time, where other conditions remain constant. Expressed in hertz per second.

Frequency Mask Trigger - A flexible real-time trigger based on specific events that occur in the frequency domain. The triggering parameters are defined by a graphical mask.

Frequency Modulation (FM) - The process in which the frequency of an electrical signal (the carrier) is varied according to the instantaneous voltage of a second electrical signal (the modulating signal).

Frequency Range - The range of frequencies over which a device operates, with lower and upper bounds.

Frequency Span - A continuous range of frequencies extending between two frequency limits.

Marker - A visually identifiable point on a waveform trace, used to extract a readout of domain and range values represented by that point.

Modulate - To vary a characteristic of a signal, typically in order to transmit information.

Noise - Unwanted random disturbances superimposed on a signal which tend to obscure that signal.

Noise Floor - The level of noise intrinsic to a system that represents the minimum limit at which input signals can be observed; ultimately limited by thermal noise (kTB).

Noise Bandwidth (NBW) - The exact bandwidth of a filter

that is used to calculate the absolute power of noise or noise-like signals in dBm/Hz.

Probability of Intercept - The certainty to which a signal can be detected within defined parameters.

Real-Time Bandwidth - The frequency span over which real-time seamless capture can be performed, which is a function of the digitizer and the IF bandwidth of a Real-Time Spectrum Analyzer.

Real-Time Seamless Capture - The ability to acquire and store an uninterrupted series of time domain samples that represent the behavior of an RF signal over a long period of time.

Real-Time Spectrum Analysis - A spectrum analysis technique based on Discrete Fourier Transforms (DFT) that is capable of continuously analyzing a bandwidth of interest without time gaps. Real-Time Spectrum Analysis provides 100% probability of display and trigger of transient signal fluctuations within the specified span, resolution bandwidth and time parameters.

Real-Time Spectrum Analyzer - Instrument capable of measuring elusive RF events in RF signals, triggering on those events, seamlessly capturing them into memory, and analyzing them in the frequency, time, and modulation domains.

Reference Level - The signal level represented by the uppermost graticule line of the analyzer display.

Resolution Bandwidth (RBW) - The width of the narrowest measurable band of frequencies in a spectrum analyzer display. The RBW determines the analyzer's ability to resolve closely spaced signal components.

Sensitivity - Measure of a spectrum analyzer's ability to display minimum level signals, usually expressed as Displayed Average Noise Level (DANL).

Spectrogram - Frequency vs. Time vs. amplitude display where the frequency is represented on x-axis and time on the y-axis. The power is expressed by the color.

Spectrum - The frequency domain representation of a signal showing the power distribution of its spectral component versus frequency.

Spectrum Analysis - Measurement technique for determining the frequency content of an RF signal.

Vector Signal Analysis - Measurement technique for characterizing the modulation of an RF signal. Vector analysis takes both magnitude and phase into account.

| | |
|--------------|--|
| ACP: | Adjacent Channel Power |
| ADC: | Analog-to-Digital Converter |
| AM: | Amplitude Modulation |
| BH4B: | Blackman-Harris 4B Window |
| BW: | Bandwidth |
| CCDF: | Complementary Cumulative Distribution Function |
| CDMA: | Code Division Multiple Access |
| CW: | Continuous Wave |
| dB: | Decibel |
| dBfs: | dB Full Scale |
| DDC: | Digital Downconverter |
| DFT: | Discrete Fourier Transform |
| DPX: | Digital Phosphor Display, Spectrum, etc. |
| DSP: | Digital Signal Processing |
| EVM: | Error Vector Magnitude |
| FFT: | Fast Fourier Transform |
| FM: | Frequency Modulation |
| FSK: | Frequency Shift Keying |
| IF: | Intermediate Frequency |
| IQ: | In-Phase Quadrature |
| LO: | Local Oscillator |
| NBW: | Noise Bandwidth |
| OFDM: | Orthogonal Frequency Division Multiplexing |
| PAR: | Peak-Average Ratio |
| PM: | Phase Modulation |
| POI: | Probability of Intercept |
| PRBS: | Pseudorandom Binary Sequence |
| PSK: | Phase Shift Keying |
| QAM: | Quadrature Amplitude Modulation |
| QPSK: | Quadrature Phase Shift Keying |
| RBW: | Resolution Bandwidth |
| RF: | Radio Frequency |
| RMS: | Root Mean Square |
| RTSA: | Real-Time Spectrum Analyzer |
| SA: | Spectrum Analyzer |
| VSA: | Vector Signal Analyzer |

Contact Tektronix:

ASEAN / Australasia (65) 6356 3900
Austria +41 52 675 3777
Balkans, Israel, South Africa and other ISE Countries +41 52 675 3777
Belgium 07 81 60166
Brazil & South America (11) 40669400
Canada 1 (800) 661-5625
Central East Europe, Ukraine and the Baltics +41 52 675 3777
Central Europe & Greece +41 52 675 3777
Denmark +45 80 88 1401
Finland +41 52 675 3777
France +33 (0) 1 69 86 81 81
Germany +49 (221) 94 77 400
Hong Kong (852) 2585-6688
India (91) 80-22275577
Italy +39 (02) 25086 1
Japan 81 (3) 6714-3010
Luxembourg +44 (0) 1344 392400
Mexico, Central America & Caribbean 52 (55) 5424700
Middle East, Asia and North Africa +41 52 675 3777
The Netherlands 090 02 021797
Norway 800 16098
People's Republic of China 86 (10) 6235 1230
Poland +41 52 675 3777
Portugal 80 08 12370
Republic of Korea 82 (2) 6917-5000
Russia & CIS +7 (495) 7484900
South Africa +27 11 206 8360
Spain (+34) 901 988 054
Sweden 020 08 80371
Switzerland +41 52 675 3777
Taiwan 886 (2) 2722-9622
United Kingdom & Eire +44 (0) 1344 392400
USA 1 (800) 426-2200
For other areas contact Tektronix, Inc. at: 1 (503) 627-7111
Updated 12 November 2007

For Further Information

Tektronix maintains a comprehensive, constantly expanding collection of application notes, technical briefs and other resources to help engineers working on the cutting edge of technology. Please visit www.tektronix.com



Copyright © 2008, Tektronix. All rights reserved. Tektronix products are covered by U.S. and foreign patents, issued and pending. Information in this publication supersedes that in all previously published material. Specification and price change privileges reserved. TEKTRONIX and TEK are registered trademarks of Tektronix, Inc. All other trade names referenced are the service marks, trademarks or registered trademarks of their respective companies.
02/08 EA/BT 37W-17249-3

Tektronix
Enabling Innovation