

INDICATOR TUBE

The type ZM1043 is electrically identical with type ZM1041 but has no filter coating. The use of a separate blue absorbing, e.g. circular polarized amber filter is recommended.

DIMENSIONS AND CONNECTIONS

Dimensions in mm

Base: B13B

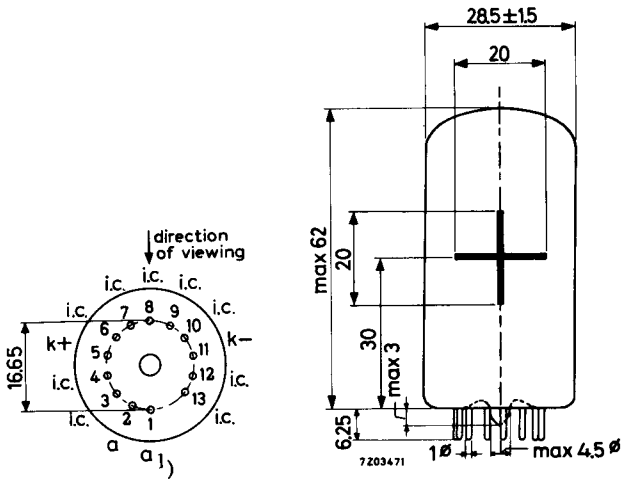

1) Pins 1 and 2 to be interconnected externally.

PHILIPS

Data handbook



Electronic
components
and materials

ZM1043

page

1
2

sheet

1
FP

date

1969.09
2000.04.21