



**ELECTRONIC
INNOVATIONS
IN ACTION**

TUBES

— PRODUCT INFORMATION —

6KR8-A

Triode-Pentode

The 6KR8-A is a miniature triode-pentode containing a medium-mu triode and a sharp-cutoff pentode. The pentode is intended for use as a video amplifier and the triode for general-purpose use.

The 6KR8-A is unilaterally interchangeable with the 6KR8.

GENERAL

ELECTRICAL

Cathode - Coated Unipotential

Heater Characteristics and Ratings

Heater Voltage, AC or DC*	6.3±0.6	Volts
Heater Current†	0.75	Amperes
Direct Interelectrode Capacitances‡		

Pentode Section

Grid-Number 1 to Plate:

(Pg1 to Pp)	0.075	pf
Input: Pg1 to (h + Pk + Pg2 + Pg3 + i.s.)	13	pf
Output: Pp to (h + Pk + Pg2 + Pg3 + i.s.)	4.4	pf

Triode Section

Grid to Plate: (Tg to Tp)	2.6	pf
Input: Tg to (h + Tk + Pk + Pg3 + i.s.)	4.2	pf
Output: Tp to (h + Tk + Pk + Pg3 + i.s.)	3.0	pf

MECHANICAL

Operating Position - Any

Envelope - T-6 1/2, Glass

Base - E9-1, Small Button 9-Pin

Outline Drawing - EIA 6-3

Maximum Diameter	0.875	Inches
Minimum Diameter	0.750	Inches
Maximum Over-all Length	2.625	Inches
Maximum Seated Height	2.375	Inches

PHYSICAL DIMENSIONS

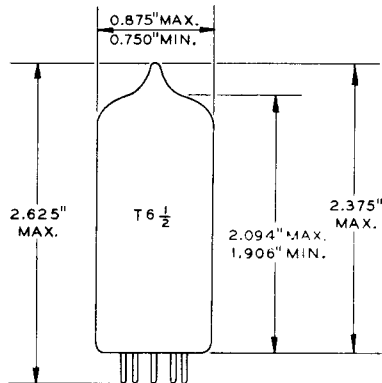

EIA 6-3

TERMINAL CONNECTIONS

- Pin 1 - Triode Cathode
- Pin 2 - Triode Grid
- Pin 3 - Triode Plate
- Pin 4 - Heater
- Pin 5 - Heater
- Pin 6 - Pentode Cathode, Grid Number 3, and Internal Shield
- Pin 7 - Pentode Grid Number 1
- Pin 8 - Pentode Grid Number 2 (Screen)
- Pin 9 - Pentode Plate

BASING DIAGRAM

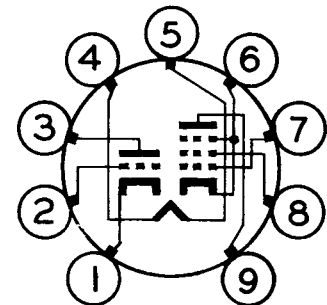

EIA 9DX

The tubes and arrangements disclosed herein may be covered by patents of General Electric Company or others. Neither the disclosure of any information herein nor the sale of tubes by General Electric Company conveys any license under patent claims covering combinations of tubes with other devices or elements. In the absence of an

express written agreement to the contrary, General Electric Company assumes no liability for patent infringement arising out of any use of the tubes with other devices or elements by any purchaser of tubes or others.

MAXIMUM RATINGS

DESIGN-MAXIMUM VALUES	Pentode Section	Triode Section	
Plate Voltage	330	330	Volts
Screen Supply Voltage	330	---	Volts
Screen Voltage - See Screen Rating Chart			
Positive DC Grid-Number 1 Voltage	0	0	Volts
Plate Dissipation	5.0	2.0	Watts
Screen Dissipation	1.5	---	Watts
Heater-Cathode Voltage			
Heater Positive with Respect to Cathode			
DC Component	100	100	Volts
Total DC and Peak	200	200	Volts
Heater Negative with Respect to Cathode			
Total DC and Peak	200	200	Volts
Grid-Number 1 Circuit Resistance			
With Fixed Bias	0.01	0.5	Megohms
With Cathode Bias	0.01	1.0	Megohms

Design-Maximum ratings are limiting values of operating and environmental conditions applicable to a bogey electron tube of a specified type as defined by its published data and should not be exceeded under the worst probable conditions.

The tube manufacturer chooses these values to provide acceptable serviceability of the tube, making allowance for the effects of changes in operating conditions due to variations in the characteristics of the tube under consideration.

The equipment manufacturer should design so that initially and throughout life no design-maximum value for the intended service is exceeded with a bogey tube under the worst probable operating conditions with respect to supply-voltage variation, equipment component variation, equipment control adjustment, load variation, signal variation, environmental conditions, and variations in the characteristics of all other electron devices in the equipment.

CHARACTERISTICS AND TYPICAL OPERATION

AVERAGE CHARACTERISTICS	Pentode Section	Triode Section	
Plate Voltage	35	200	125 Volts
Screen Voltage	100	100	--- Volts
Grid-Number 1 Voltage	0	---	--- Volts
Cathode-Bias Resistor	---	82	68 Ohms
Amplification Factor	---	---	46
Plate Resistance, approximate	---	60000	4400 Ohms
Transconductance	---	20000	10400 Micromhos
Plate Current	54	19.5	15 Milliamperes
Screen Current	13.5	3.0	--- Milliamperes
Grid-Number 1 Voltage, approximate			
I _b = 10 Microamperes	---	---	-8 Volts
Grid-Number 1 Voltage, approximate			
I _b = 100 Microamperes	---	-6.3	--- Volts

NOTES

- * The equipment designer should design the equipment so that heater voltage is centered at the specified bogey value, with heater supply variations restricted to maintain heater voltage within the specified tolerance.
- † Heater current of a bogey tube at E_f = 6.3 volts.
- § Without external shield.

SCREEN RATING CHART

PENTODE SECTION

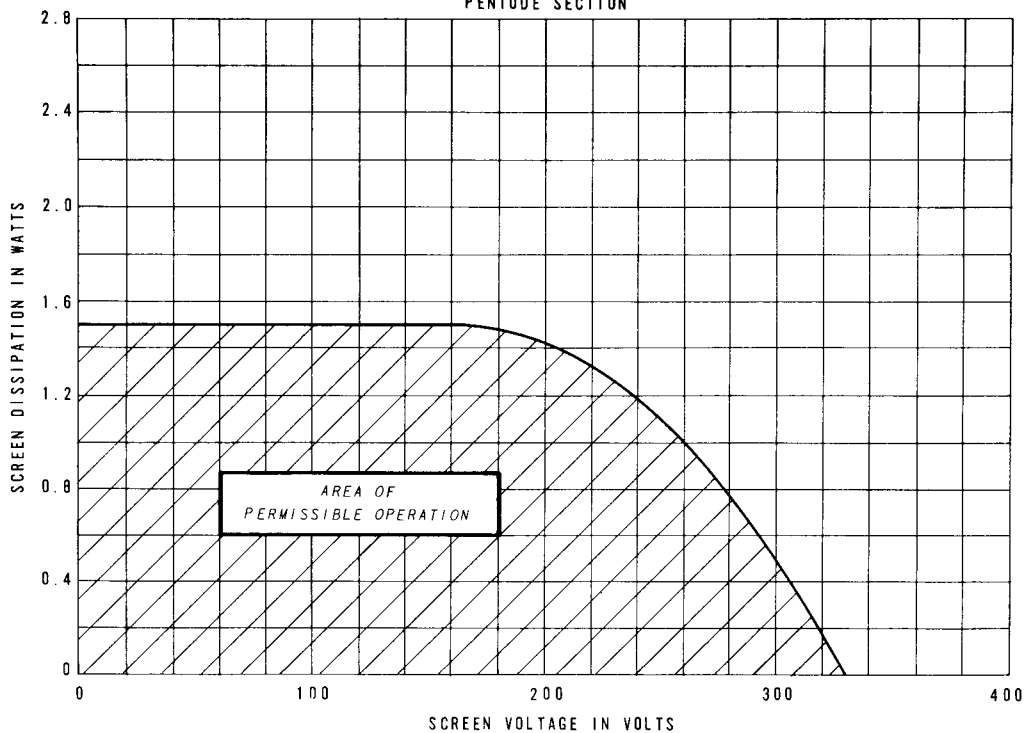

AVERAGE PLATE CHARACTERISTICS

PENTODE SECTION

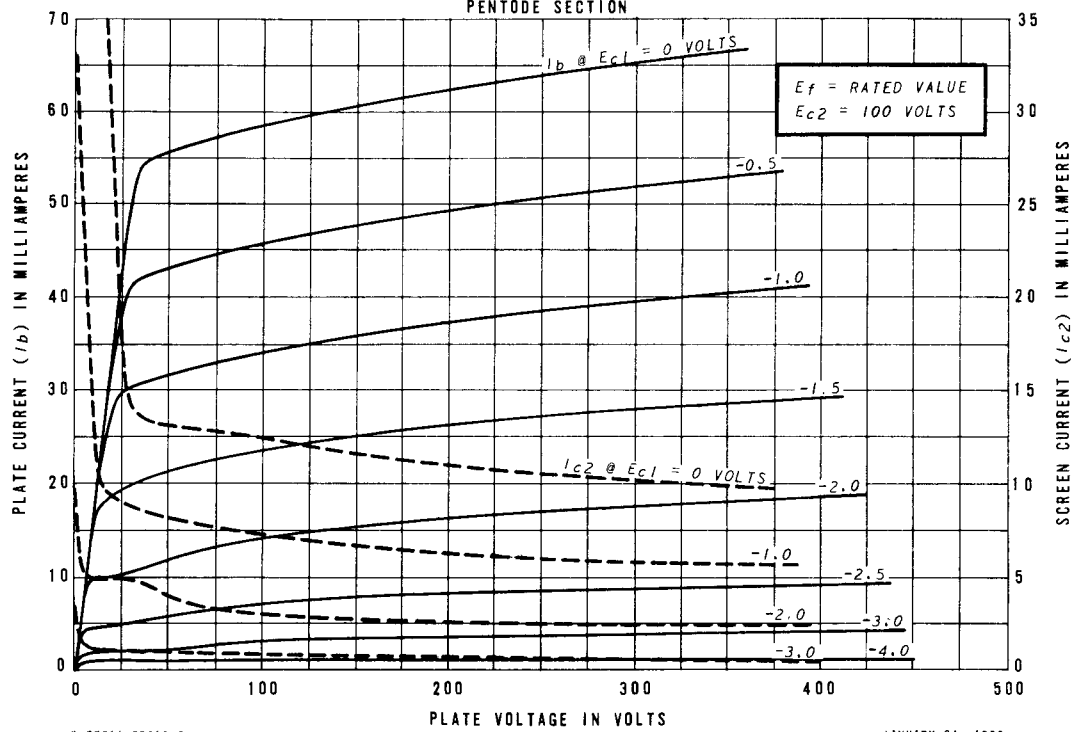

AVERAGE PLATE CHARACTERISTICS

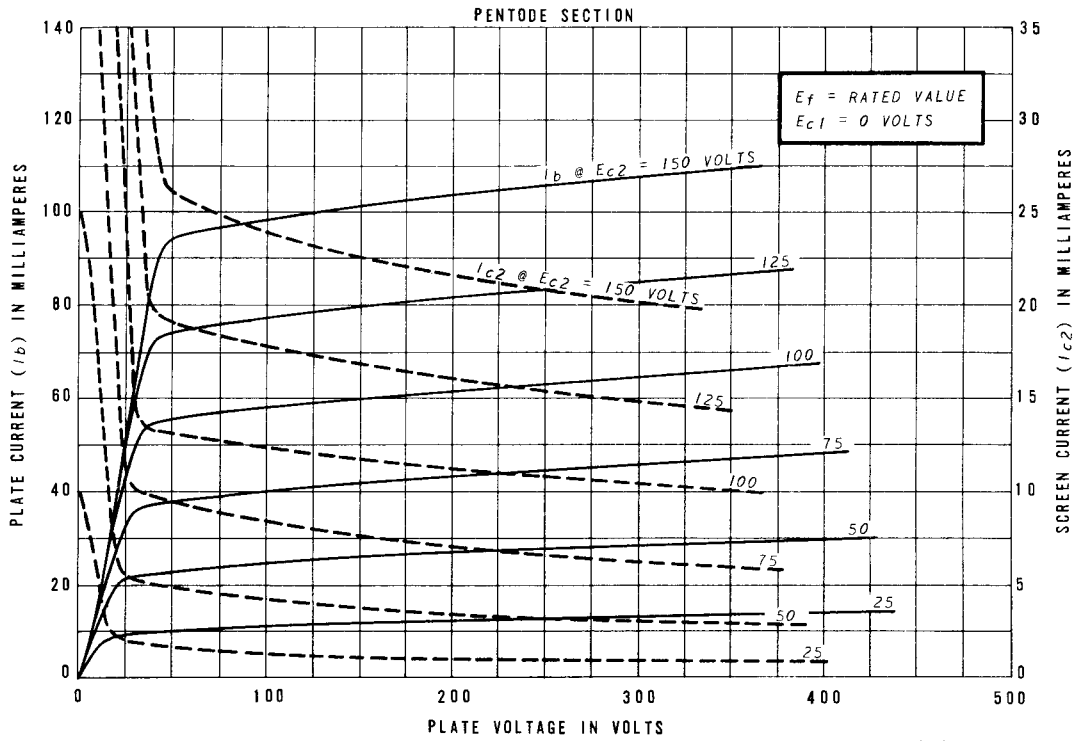

AVERAGE TRANSFER CHARACTERISTICS

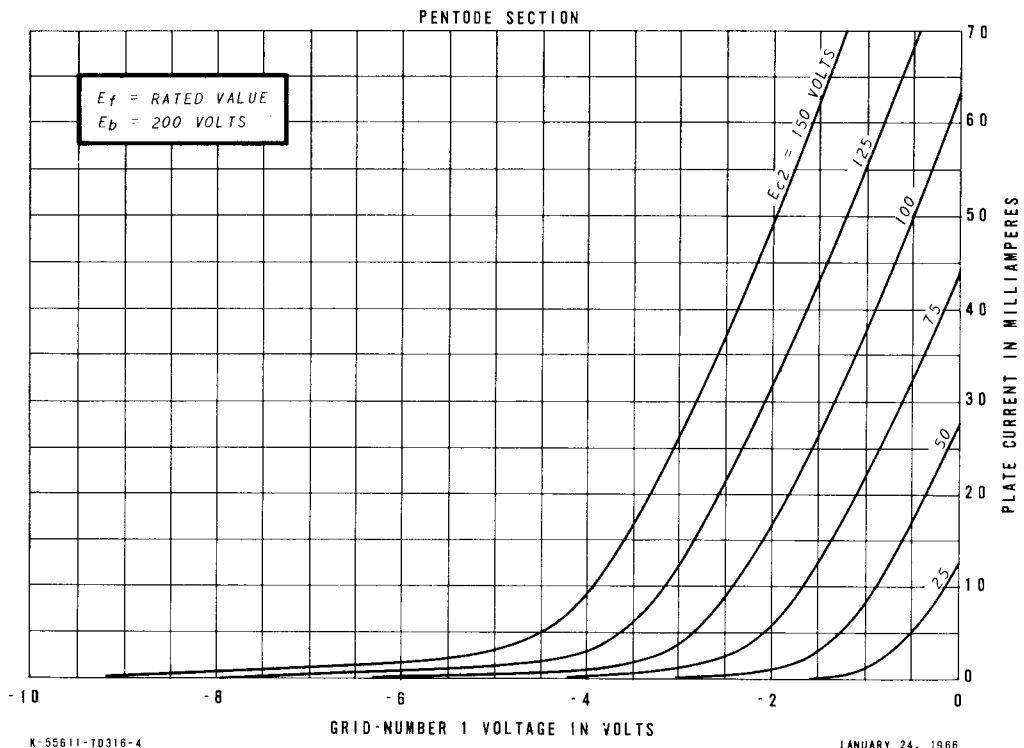

AVERAGE TRANSFER CHARACTERISTICS

PENTODE SECTION

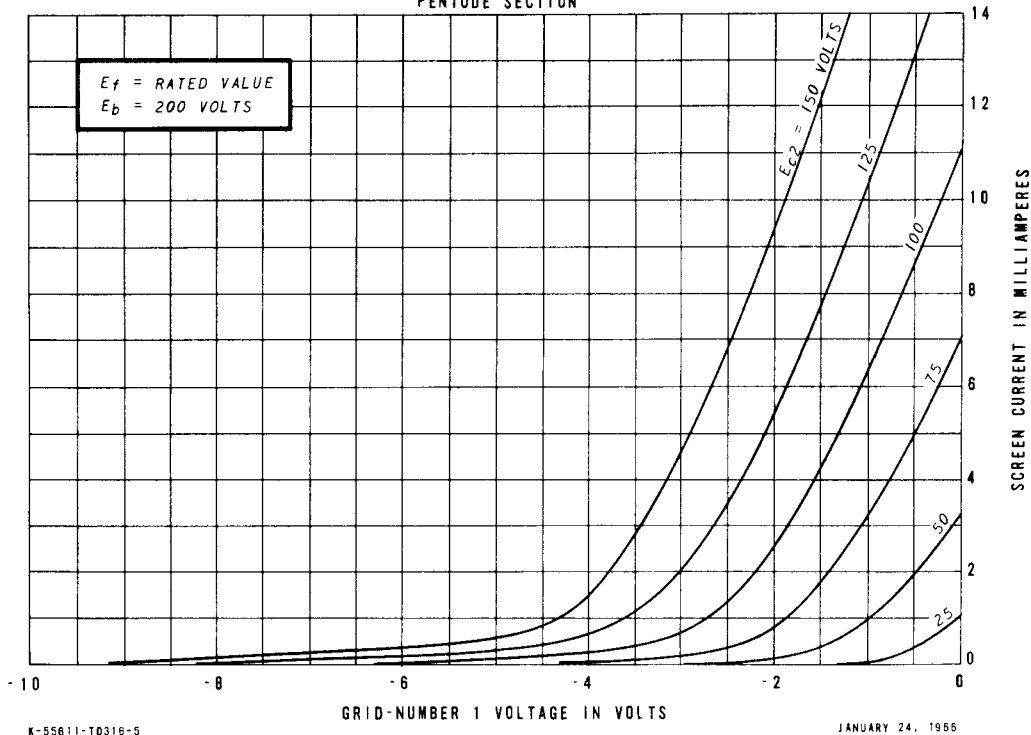

AVERAGE TRANSFER CHARACTERISTICS

PENTODE SECTION

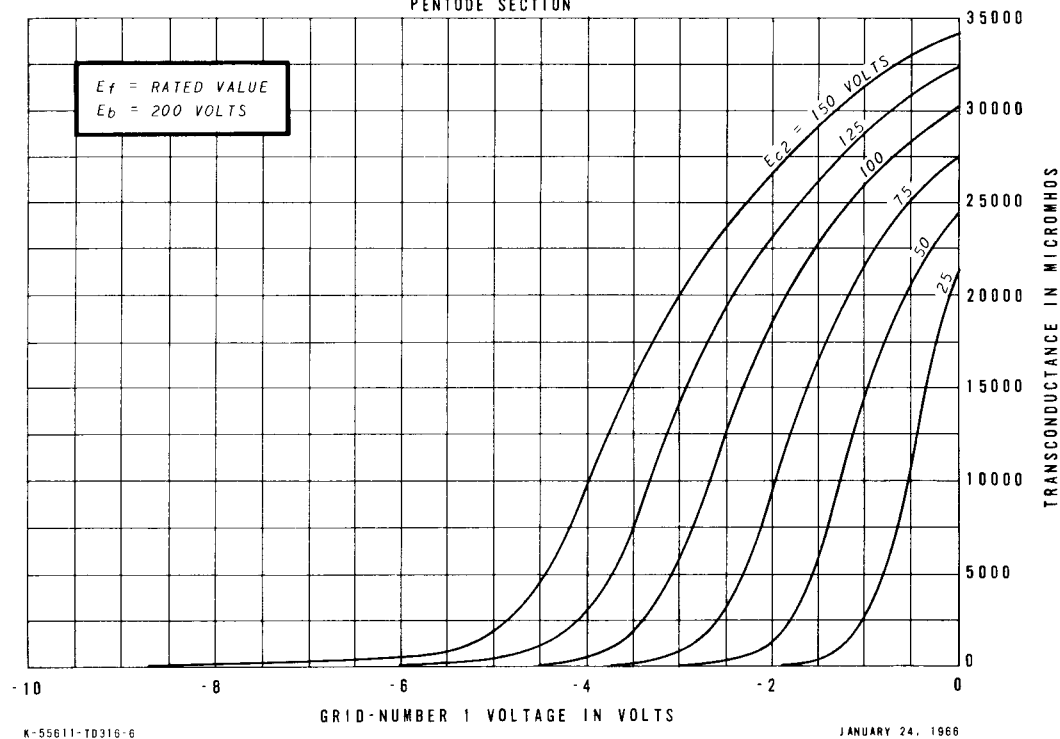

AVERAGE PLATE CHARACTERISTICS

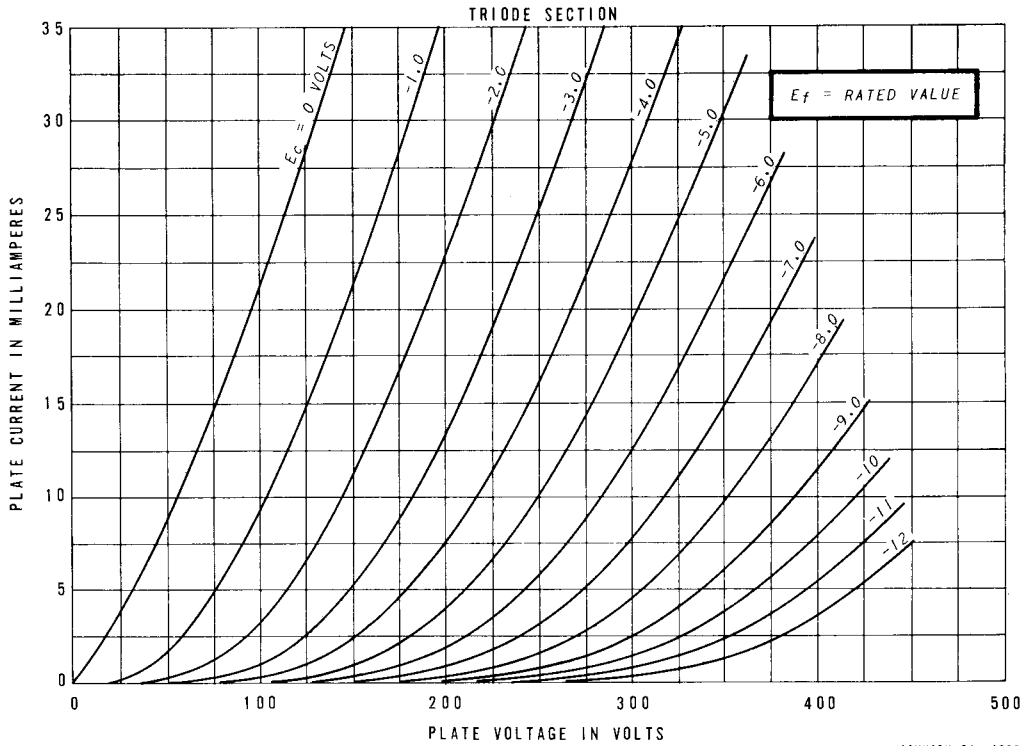

AVERAGE TRANSFER CHARACTERISTICS

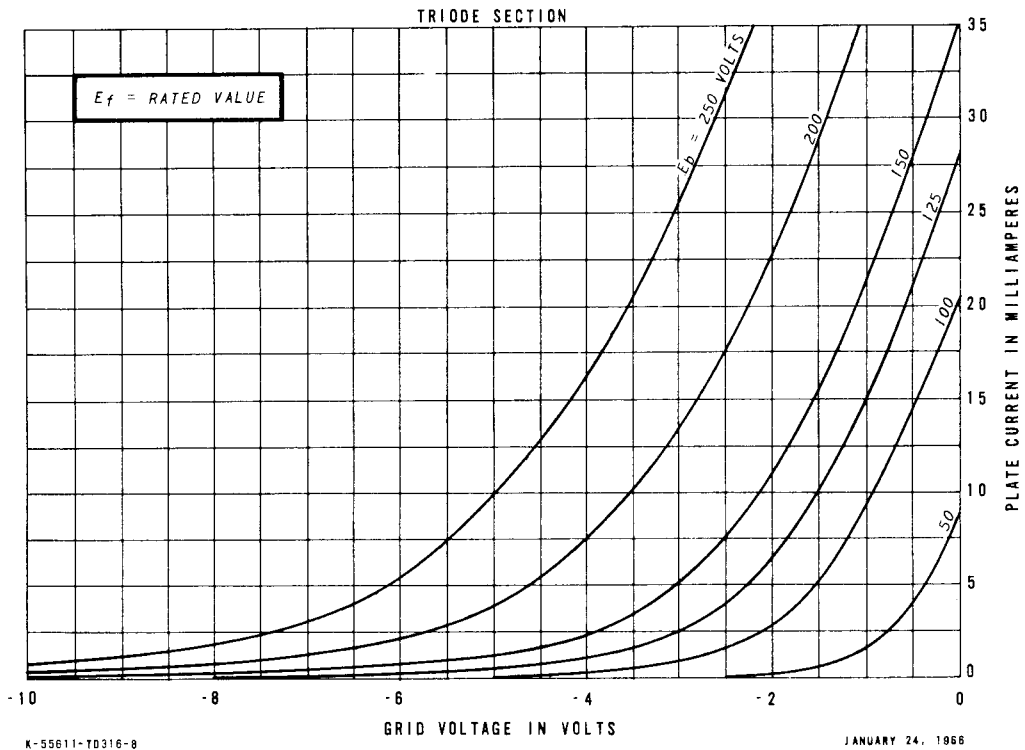

AVERAGE CHARACTERISTICS

TRIODE SECTION

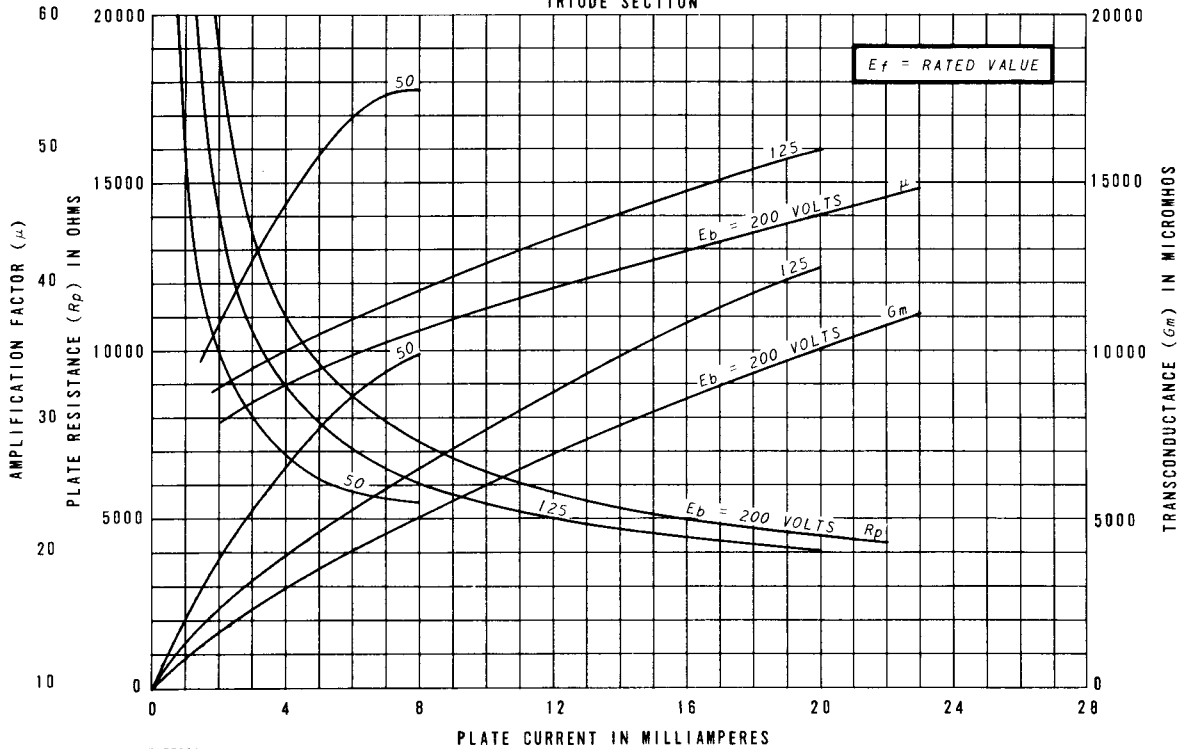

K-55611-TD316-9

JANUARY 24, 1966