

TUNG-SOL

BEAM PENTODE

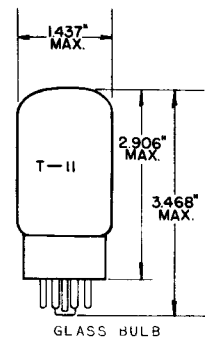

GLASS BULB
SHORT INTERMEDIATE SHELL
7 PIN OCTAL R7-47
OUTLINE 11-1

COATED UNIPOTENTIAL CATHODE

HEATER
6.3 VOLTS 900 MA.
AC OR DC

ANY MOUNTING POSITION

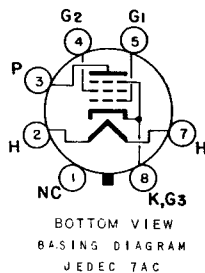

THE 5881 IS THE ELECTRICAL EQUIVALENT TO TYPES 6L6 AND 6L6G EXCEPT THAT THE PLATE AND SCREEN DISSIPATION RATINGS HAVE BEEN INCREASED APPROXIMATELY 20 PERCENT. IT EMBODIES A COMPLETE MECHANICAL REDESIGN WHICH RESULTS IN GREATER RESISTANCE TO SHOCK AND VIBRATION. THE USE OF TREATED GRIDS AND ANODE GREATLY INCREASES ITS OVERLOAD CAPABILITIES AND THEREBY PROVIDES DESIRABLE IMPROVEMENT IN CONTINUITY OF SERVICE. THE ADDITION OF A LOW-LOSS BARRIER TYPE BASE WILL PROVIDE OBVIOUS ADVANTAGES IN CERTAIN APPLICATIONS.

RATINGS

INTERPRETED ACCORDING TO DESIGN CENTER SYSTEM

MAXIMUM HEATER-CATHODE VOLTAGE	200	VOLTS
MAXIMUM PLATE VOLTAGE	400	VOLTS
MAXIMUM GRID #2 VOLTAGE	400	VOLTS
MAXIMUM PLATE VOLTAGE (TRIODE CONNECTION)	400	VOLTS
MAXIMUM PLATE DISSIPATION	23	WATTS
MAXIMUM GRID #2 DISSIPATION	3	WATTS
MAXIMUM PLATE DISSIPATION (TRIODE CONNECTION)	26	WATTS
MAXIMUM GRID RESISTANCE (FIXED BIAS)	0.1	MEGOHM
MAXIMUM GRID RESISTANCE (SELF BIAS)	0.5	MEGOHM

TYPICAL OPERATING CONDITIONS AND CHARACTERISTICS

CLASS A₁ AMPLIFIER - SINGLE TUBE

PLATE VOLTAGE	250	300	350	VOLTS
GRID #2 VOLTAGE	250	200	250	VOLTS
GRID #1 VOLTAGE	-14	-12.5	-18	VOLTS
PEAK AF SIGNAL VOLTAGE	14	12.5	18	VOLTS
TRANSCONDUCTANCE	6 100	5 300	5 200	μMHOS
PLATE RESISTANCE	30 000	35 000	48 000	OHMS
ZERO-SIGNAL PLATE CURRENT	75	48	53	MA.
ZERO-SIGNAL GRID #2 CURRENT	4.3	2.5	2.5	MA.
MAXIMUM SIGNAL PLATE CURRENT	80	55	65	MA.
MAXIMUM SIGNAL GRID #2 CURRENT	7.6	4.7	8.5	MA.
LOAD RESISTANCE	2 500	4 500	4 200	OHMS
POWER OUTPUT	6.7	6.5	11.3	WATTS
TOTAL HARMONIC DISTORTION	10	11	13	PERCENT

CONTINUED ON FOLLOWING PAGE

TUNG-SOL

CONTINUED FROM PRECEDING PAGE

CLASS A₁ AMPLIFIER - SINGLE TUBE - TRIODE CONNECTION

GRID #2 CONNECTED TO PLATE

PLATE VOLTAGE	250	300	VOLTS
GRID VOLTAGE	-18	-20	VOLTS
PEAK AF SIGNAL VOLTAGE	18	20	VOLTS
ZERO-SIGNAL PLATE CURRENT	52	78	MA.
MAXIMUM SIGNAL PLATE CURRENT	58	85	MA.
AMPLIFICATION FACTOR	8	---	
TRANSCONDUCTANCE	5 250	---	μMHOS
LOAD RESISTANCE	4 000	4 000	OHMS
TOTAL HARMONIC DISTORTION	6	5.5	PERCENT
POWER OUTPUT	1.4	1.8	WATTS

CLASS A₁ PUSH-PULL AMPLIFIER

VALUES ARE FOR TWO TUBES

PLATE VOLTAGE	250	270	VOLTS
GRID #2 VOLTAGE	250	270	VOLTS
GRID #1 VOLTAGE	-16	-17.5	VOLTS
PEAK AF GRID TO GRID VOLTAGE	32	35	VOLTS
TRANSCONDUCTANCE (EACH TUBE)	5 500	5 700	μMHOS
PLATE RESISTANCE (EACH TUBE)	24 500	23 500	OHMS
ZERO-SIGNAL PLATE CURRENT	120	134	MA.
ZERO-SIGNAL GRID #2 CURRENT	10	11	MA.
MAXIMUM SIGNAL PLATE CURRENT	140	155	MA.
MAXIMUM SIGNAL GRID #2 CURRENT	16	17	MA.
LOAD RESISTANCE	5 000	5 000	OHMS
POWER OUTPUT	14.5	17.5	WATTS
TOTAL HARMONIC DISTORTION	2	2	PERCENT

CLASS AB₁ PUSH-PULL AMPLIFIER

VALUES ARE FOR TWO TUBES

PLATE VOLTAGE	360	360	VOLTS
GRID #2 VOLTAGE	270	270	VOLTS
GRID #1 VOLTAGE	-22.5	-22.5	VOLTS
PEAK AF GRID TO GRID VOLTAGE	45	45	VOLTS
ZERO-SIGNAL PLATE CURRENT	88	88	MA.
ZERO-SIGNAL GRID #2 CURRENT	5	5	MA.
MAXIMUM SIGNAL PLATE CURRENT	132	140	MA.
MAXIMUM SIGNAL GRID #2 CURRENT	15	11	MA.
LOAD RESISTANCE	6 600	3 800	OHMS
POWER OUTPUT	26.5	18	WATTS
TOTAL HARMONIC DISTORTION	2	2	PERCENT

CONTINUED ON FOLLOWING PAGE

TUNG-SOL

CONTINUED FROM PRECEDING PAGE

CLASS AB₁ PUSH-PULL AMPLIFIER - TRIODE CONNECTIONGRID #2 CONNECTED TO PLATE
VALUES ARE FOR TWO TUBES

HEATER VOLTAGE	6.3	VOLTS
HEATER CURRENT	0.9	AMP.
PLATE VOLTAGE	400	VOLTS
GRID VOLTAGE	-45	VOLTS
PEAK AF GRID TO GRID VOLTAGE	90	VOLTS
ZERO-SIGNAL PLATE CURRENT	65	MA.
MAXIMUM SIGNAL PLATE CURRENT	130	MA.
LOAD RESISTANCE	4 000	OHMS
TOTAL HARMONIC DISTORTION	4.4	PERCENT
POWER OUTPUT	13.3	WATTS

CLASS AB₂ PUSH-PULL AMPLIFIER

VALUES ARE FOR TWO TUBES

HEATER VOLTAGE	6.3	6.3	VOLTS
HEATER CURRENT	0.9	0.9	AMP.
PLATE VOLTAGE	360	360	VOLTS
GRID #2 VOLTAGE	225	270	VOLTS
GRID #1 VOLTAGE	-18	-22.5	VOLTS
PEAK AF GRID TO GRID VOLTAGE	52	72	VOLTS
ZERO-SIGNAL PLATE CURRENT	78	88	MA.
ZERO-SIGNAL GRID #2 CURRENT	3.5	5	MA.
MAXIMUM SIGNAL PLATE CURRENT	142	205	MA.
MAXIMUM SIGNAL GRID #2 CURRENT	11	16	MA.
LOAD RESISTANCE	6 000	3 800	OHMS
POWER OUTPUT	31	47	WATTS
TOTAL HARMONIC DISTORTION	2	2	PERCENT

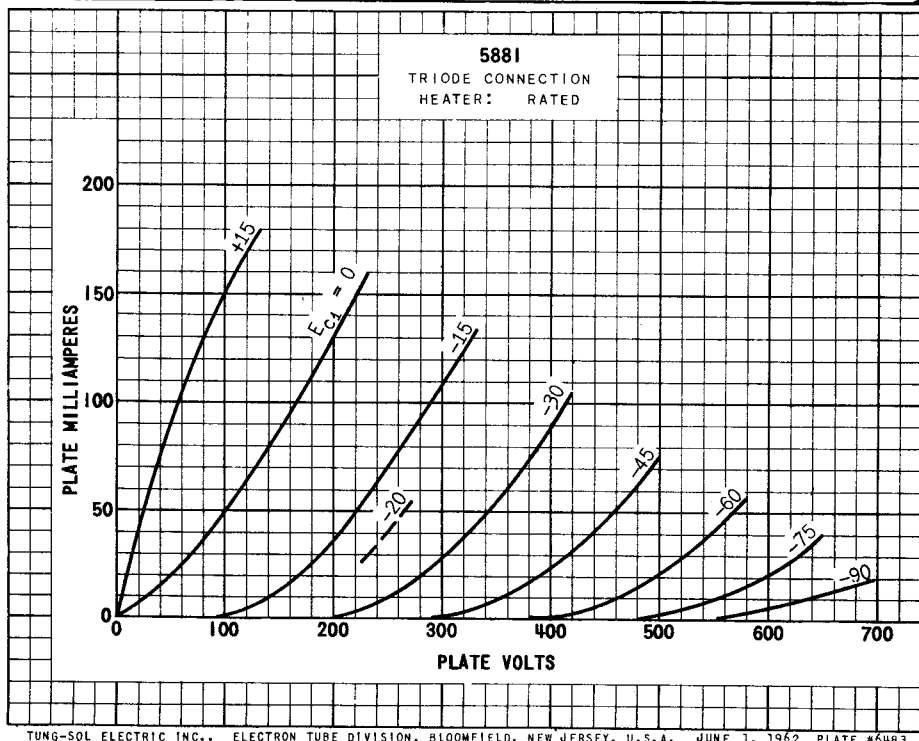

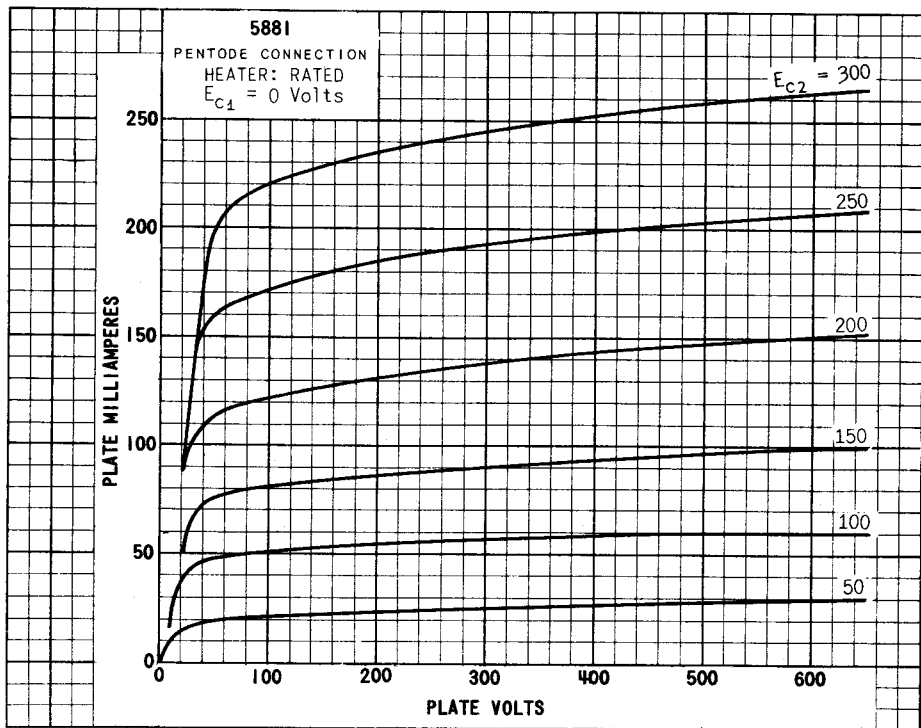
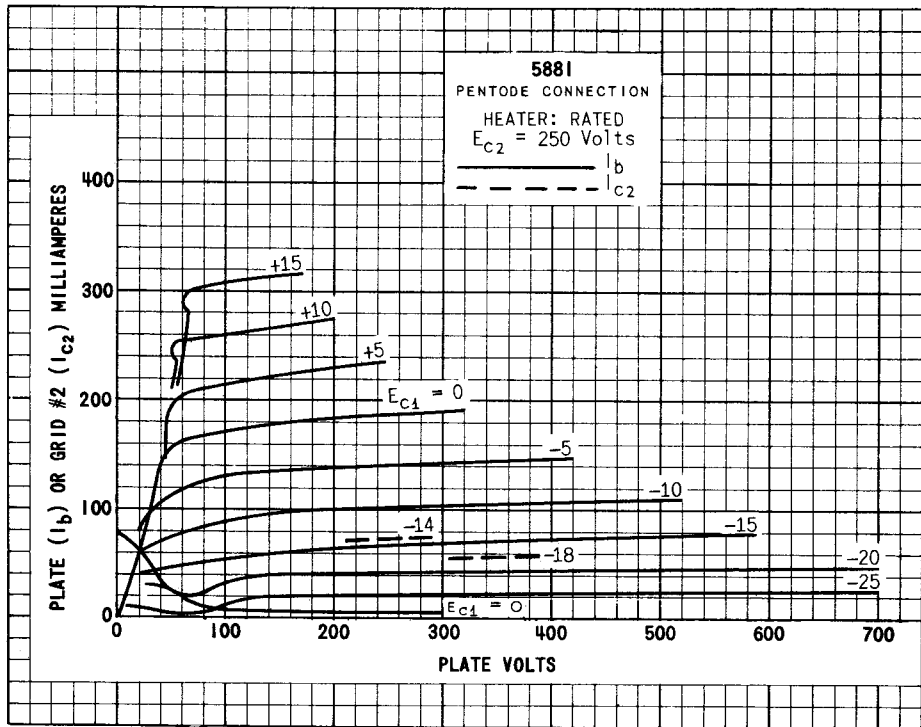

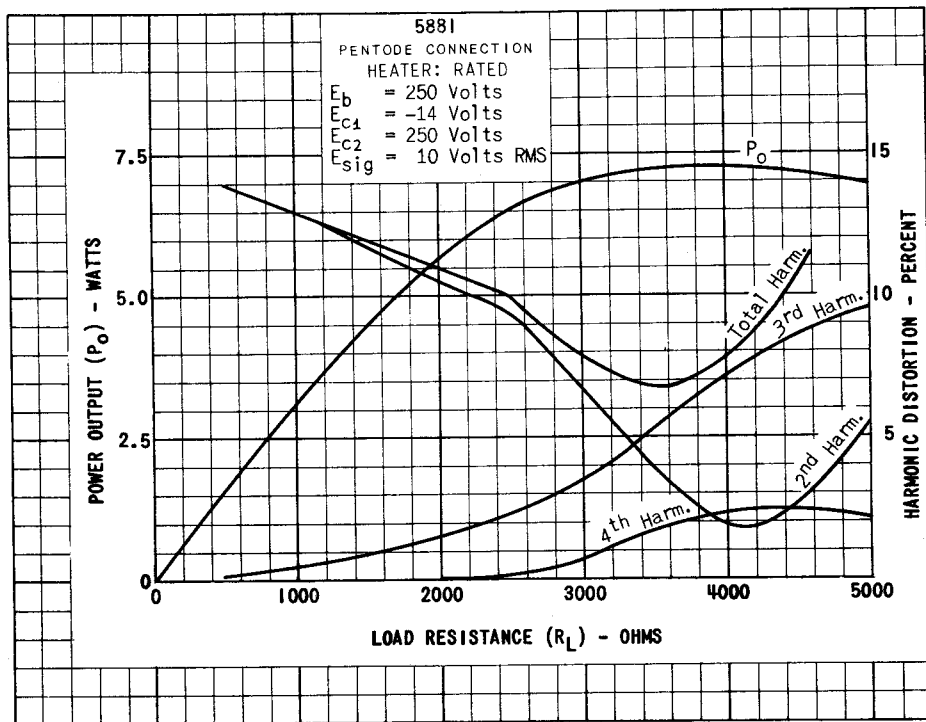
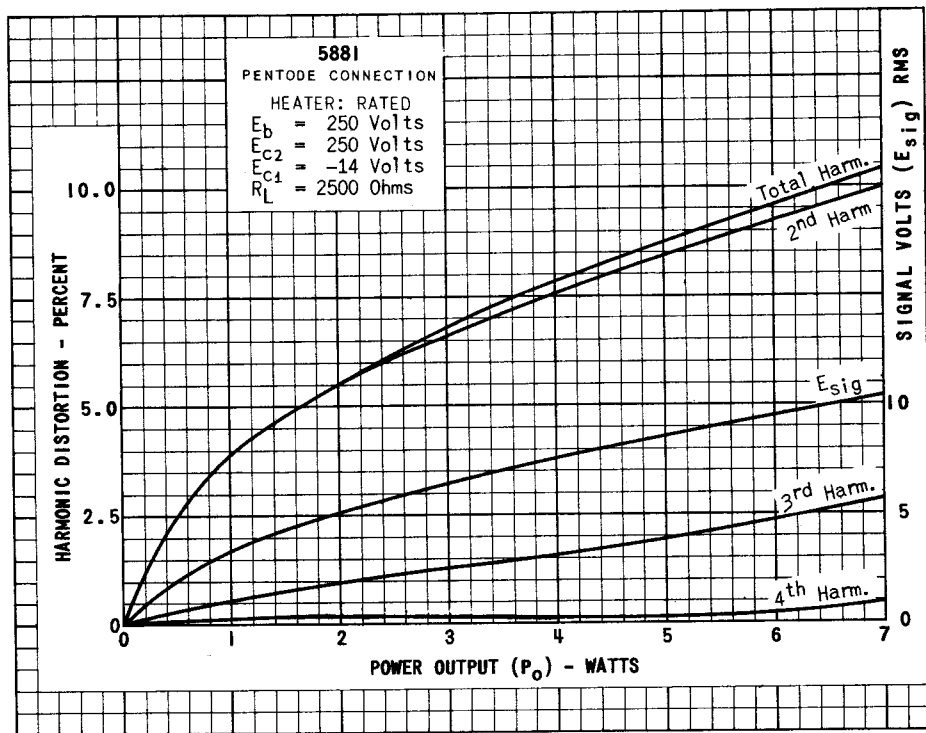

TUNG-SOL

ULTRA-LINEAR OUTPUT STAGE

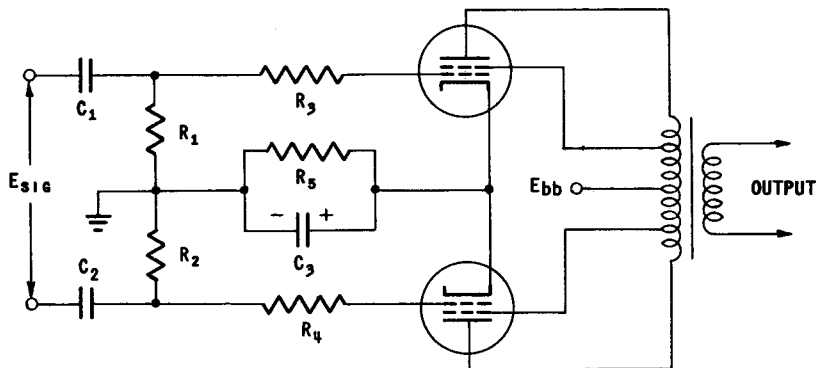

$$R_1, R_2 = 100 \text{ K. } 1/2\text{W}$$

$$R_3, R_4 = 1 \text{ K. } 1/2\text{W}$$

$$R_5 = 400 \text{ OHMS } 10\text{W}$$

$$E_b = 450\text{V.}$$

$$E_{SIG} = 80\text{V. PEAK TO PEAK}$$

$$C_1, C_2 = 0.2 \mu\text{f } 600\text{V}$$

$$C_3 = 100 \mu\text{f } 50\text{V.}$$

$$\text{DIST.} = 2.5\%$$

$$P_o = 20\text{W}$$

$$R_l = 6\text{K}$$

IN THE ULTRA-LINEAR CIRCUIT THE SCREEN VOLTAGES ARE DERIVED FROM TAPS ON THE PLATE WINDINGS OF THE OUTPUT TRANSFORMER, THE TAPS ARE LOCATED SO AS TO APPLY 43% OF THE PLATE SIGNAL VOLTAGE TO THE SCREEN GRID.

THE PLATE FAMILY FOR THIS CONNECTION IS SHOWN BELOW. THESE CURVES WERE OBTAINED BY STATICALLY VARYING THE PLATE VOLTAGE IN INCREMENTS ABOUT THE QUIESCENT POINT (400 VOLTS PLATE AND SCREEN SUPPLY) AND SIMULTANEOUSLY CHANGING THE SCREEN VOLTAGE BY 43% OF THE INCREMENT. IN THE GRAPH BOTH PLATE AND SCREEN VOLTAGES HAVE BEEN PLOTTED ALONG THE ABSCISSA.

