

5762/7C24

Power Triode

VHF GRID-DRIVE OR CATHODE-DRIVE OPERATION

INTEGRAL RADIATOR	4000 WATTS CW OUTPUT AT 220 Mc/s
FORCED-AIR COOLED	7000 WATTS CW OUTPUT AT 30 Mc/s
THORIATED-TUNGSTEN FILAMENT	6350 WATTS VHF TV OUTPUT AT 216 Mc/s

For Use In VHF Television and CW Service in
Stationary and Portable Equipment

ELECTRICAL

Filamentary Cathode, Thoriated-Tungsten Type⁹

Voltage (AC or DC)	{ 12.6 typ V	V
	{ 13.2 max V	V
Current:		
Typical value at 12.6 volts.	29	A
For starting, even momentarily	175 max	A
Cold Resistance.	0.052	Ω
Heating Time	15 min	s
Amplification Factor	29	
Direct Interelectrode Capacitances		
Grid to plate.	18	pF
Grid to filament	19	pF
Plate to filament.	0.5	pF

MECHANICAL

Operating Position	Vertical, either end up
Maximum Overall Length	7.12 in
Maximum Diameter (See <i>Dimensional Outline</i>)	4.68 in
Weight (Approx.)	6-1/4 lbs
Radiator	Integral part of tube
Terminal Connections (See <i>Dimensional Outline</i>)	

- F - Filament
- F_M - Filament
 Mid-Tap
- G - Grid Terminal
 (Flange)
- P - Plate Terminal
 (Radiator)

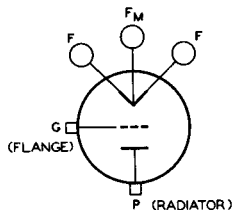

THERMAL

Air Flow^h

Through Radiator—Adequate air flow to limit the plate-core temperature to 180° C should be delivered by a blower through the radiator before and during the application of all voltages. The flow of incoming air at temperatures up to 45° C are given for various plate dissipations indicated in the following tabulation:



5762/7C24

Percentage of maximum rated plate dissipation for each class of service.

	100	80	60	per cent
→ Minimum air flow	300	214	125	cfm
→ Static pressure	2.9	1.47	0.58	in. of water

To grid and filament terminals 10 min. cfm

The specified air flow from a 1"-diameter nozzle should be directed into the filament header before and during the application of any voltages in order to limit the temperature of the filament and grid terminals to the specified maximum value.

During standby operation—Cooling air is required when heater voltage is applied to the tube.

Terminal Temperature (Filament, grid, and plate)	180 max	°C
Plate Core Temperature (See <i>Dimensional Outline</i>)	180 max	°C
Bulb Temperature (At hottest part)	180 max	°C

AF POWER AMPLIFIER & MODULATOR — CLASS B^j

Maximum CCS Ratings, Absolute-Maximum Values

DC Plate Voltage	6200	V
Max.-Signal DC Plate Current	1.5	A
Max.-Signal Plate Input	8700	W
→ Plate Dissipation	4000	W

Typical Operation

Values are for 2 tubes

DC Plate Voltage	4700	V
DC Grid Voltage	-200	V
Peak AF Grid-to-Grid Voltage	900	V
Zero-Signal DC Plate Current	0.3	A
Max.-Signal DC Plate Current	2.8	A
Effective Load Resistance (Plate to plate)	3640	Ω
Max.-Signal Driving Power (Approx.)	195	W
Max.-Signal Power Output (Approx.)	8800	W

RF POWER AMPLIFIER — CLASS B TELEVISION SERVICE^j

Synchronizing-level conditions per tube unless otherwise specified at frequency of 54 to 216 Mc/s

Maximum CCS Ratings, Absolute-Maximum Values

DC Plate Voltage	4500	V
DC Plate Current	2	A
DC Grid Current (Pedestal level)	0.325	A
Plate Input	9000	W
Plate Dissipation	4000	W

Typical Operation in Cathode-Drive Circuit

	Bandwidth of			
	10	8.5	6	Mc/s
DC Plate Voltage	3000	3200	4300	V
DC Grid Voltage	-105	-110	-150	V
Peak RF Grid Voltage				
Synchronizing level	380	435	500	V
Pedestal level	290	310	355	V

→ Indicates a change.



	<i>Bandwidth of</i>			
	10	8.5	6.0	<i>Mc/s</i>
DC Plate Current				
Synchronizing level	1.8	1.8	2	A
Pedestal level	1.36	1.35	1.5	A
DC Grid Current				
Synchronizing level	0.265	0.400	0.439	A
Pedestal level	0.115	0.130	0.118	A
Driving Power (Approx.)				
Synchronizing level	625	770	983	W
Power Output (Approx.)				
Synchronizing level	3150	4000	6350	W
Pedestal level	1800	2300	3590	W

**GRID-MODULATED RF POWER AMPLIFIER^J
CLASS C TELEVISION SERVICE**

Synchronizing-level conditions per tube unless otherwise specified. At frequency of 54 to 216 Mc/s

Maximum CCS Ratings, Absolute-Maximum Values

DC Plate Voltage	3700	V
DC Grid Voltage (White level)	-800	V
DC Plate Current	1.9	A
DC Grid Current (Pedestal level)	0.225	A
Plate Input	6500	W
Plate Dissipation	4000	W ←

Typical Operation in Cathode-Drive Circuit

	<i>Bandwidth of</i>		
	8.5	<i>Mc/s</i>	
DC Plate Voltage	3200		V
DC Grid Voltage			
Synchronizing level	-110		V
Pedestal level	-220		V
White level	-520		V
Peak RF Grid Voltage	435		V
DC Plate Current			
Synchronizing level	1.8		A
Pedestal level	1.25		A
DC Grid Current (Approx.)			
Synchronizing level	0.400		A
Pedestal level	0.130		A
Driving Power (Approx.)			
Synchronizing level	770		W
Power Output (Approx.)			
Synchronizing level	4000		W
Pedestal level	2300		W

PLATE-MODULATED RF POWER AMPLIFIER — CLASS C TELEPHONY^J

Carrier conditions per tube for use with a maximum modulation factor of 1

Maximum CCS Ratings, Absolute-Maximum Values

DC Plate Voltage	5000	V
DC Grid Voltage	-1000	V
DC Plate Current	1	A
DC Grid Current	0.3	A
Plate Input	5000	W
Plate Dissipation	2700	W ←



5762/7C24

Typical Operation in Grid-Drive Circuit

	Up to 30 Mc/s	At 110 Mc/s	
DC Plate Voltage	4700	4000	V
DC Grid Voltage	-400	-350	V
From a grid resistor of	1425	1460	Ω
Peak RF Grid Voltage ^a	675	600	V
DC Plate Current	0.96	0.93	A
DC Grid Current (Approx.).	0.28	0.24	A
Driving Power (Approx.).	170	130	W
Power Output (Approx.)	3700	2800	W

Typical Operation in Cathode-Drive Circuit

	Up to 30 Mc/s	At 110 Mc/s	
DC Plate Voltage	4700	4000	V
DC Grid Voltage	-400	-350	V
From a grid resistor of	1425	1460	Ω
Peak RF Grid Voltage	675	600	V
DC Plate Current	0.96	0.93	A
DC Grid Current (Approx.).	0.28	0.24	A
Driving Power (Approx.) ^b	720	600	W
Power Output (Approx.)	4200	3200	W

RF POWER AMPLIFIER & OSCILLATOR — CLASS C TELEGRAPHY^j AND

RF POWER AMPLIFIER — CLASS C FM TELEPHONY

Maximum CCS Ratings, Absolute-Maximum Values

DC Plate Voltage	6200	V
DC Grid Voltage	-1000	V
DC Plate Current	1.4	A
DC Grid Current	0.3	A
Plate Input	8700	W
→ Plate Dissipation	4000	W

Typical Operation in Grid-Drive Circuit

	Up to 30 Mc/s	
DC Plate Voltage	6000	V
DC Grid Voltage	-550	V
From a fixed supply of	1900	Ω
From a grid resistor of	360	Ω
From a cathode resistor of	875	V
Peak RF Grid Voltage	1.25	A
DC Plate Current	0.290	A
DC Grid Current (Approx.).	225	W
Driving Power (Approx.).	6000	W
Power Output (Approx.)		

Typical Operation in Cathode-Drive Circuit

	Up to 30 Mc/s	At 110 Mc/s	At 220 Mc/s	
DC Plate Voltage	6000	5000	4300	V

→ Indicates a change.



	Up to 30 Mc/s	At 110 Mc/s	At 220 Mc/s	
DC Grid Voltage				
From a fixed supply of . . .	-550	-1000	-200	V
From a grid resistor of . . .	1900	4100	807	Ω
From a cathode resistor of . . .	360	740	134	Ω
Peak RF Grid Voltage	875	1350	432	V
DC Plate Current	1.25	1.1	1.25	A
DC Grid Current (Approx.)	0.290	0.245	0.25	A
Driving Power (Approx.)	1225	1680	542	W
Power Output (Approx.)	7000	5500	4000	W

SELF-RECTIFYING OSCILLATOR OR AMPLIFIER — CLASS C^j

Maximum CCS Ratings, Absolute-Maximum Values

AC Plate Voltage (RMS)	7000	V
DC Grid Voltage	-300	V
DC Plate Current	0.635	A
DC Grid Current	0.135	A
Plate Input ^c	4900	W
Plate Dissipation	4000	W ←

Typical Operation

AC Plate Voltage (RMS)	6600	V
DC Grid Voltage	-127	V
DC Plate Current	0.625	A
DC Grid Current (Approx.)	0.105	A
Driving Power (Approx.) ^d	60	W
Power Output (Approx.)	3350	W

AMPLIFIER OR OSCILLATOR — CLASS C^j

*With separate, rectified, unfiltered,
single-phase, full-wave plate supply*

Maximum CCS Ratings, Absolute-Maximum Values

DC Plate Voltage	5600	V
DC Grid Voltage	-600	V
DC Plate Current	1.25	A
DC Grid Current	0.270	A
Plate Input ^e	8600	W
Plate Dissipation	4000	W ←

Typical Operation

DC Plate Voltage	5000	V
DC Grid Voltage	-260	V
DC Plate Current	1.2	A
DC Grid Current (Approx.)	0.260	A
Driving Power (Approx.) ^f	150	W
Power Output (Approx.)	5650	W

^a Driver modulated approximately 30%.

^b Carrier power of driver modulated 100%.

^c Plate input is 1.11 times the product of the ac voltage (rms) and the dc plate current.

^d From a self-rectified driver.

← Indicates a change.



5762/7C24

^e Plate input is 1.23 times the product of the dc plate voltage and the dc plate current.

^f From a driver with a rectified, unfiltered, single-phase, full-wave plate supply.

The following footnotes apply to the *RCA Transmitting Tube Operating Considerations* given at front of this section.

^g See Electrical Considerations-Filament or Heater.

^h See Cooling Considerations-Forced-Air Cooling.

^j See Classes of Service.

RATINGS VS FREQUENCY

FREQUENCY	30	110	220	Mc/s	
Maximum Permissible Percentage of Maximum Rated Plate Voltage and Plate Input					
Class B Television Service	Full Ratings—54 to 216 Mc/s				
Class C Television Service	Full Ratings—54 to 216 Mc/s				
Class C Telephony, Plate-Modulated	100	84	72	%	
Class C Telegraphy and FM Telephony	100	84	72	%	
Class C Amplifier or Oscillator, Self-Rectifying	100	84	72	%	
Class C Amplifier or Oscillator with Separate, Rectified, Unfiltered Plate Supply	100	84	72	%	
Maximum Permissible Percentage of Maximum Rated DC Grid Voltage and DC Grid Current					
Class B Television Service	Full Ratings—54 to 216 Mc/s				
Class C Television Service	Full Ratings—54 to 216 Mc/s				
			Volt.	Cur.	
Class C Telephony, Plate-Modulated	100	100	60	83	%
Class C Telegraphy and FM Telephony	100	100	60	83	%
Class C Amplifier or Oscillator, Self-Rectifying	100	100	60	83	%
Class C Amplifier or Oscillator with Separate, Rectified, Unfiltered Plate Supply	100	100	60	83	%

CHARACTERISTICS RANGE VALUES

	Note	Min	Max	
Filament Current	1	27	31	A
Amplification Factor	1,2	25	33	
Direct Interelectrode Capacitances				
Grid to plate.	-	16.5	20.5	pF
Grid to filament.	-	15.5	22.5	pF
Plate to filament.	-	0.38	0.62	pF

→ Indicates a change.



5762/7C24

	Note	Min	Max	
Grid Voltage	1,3	-125	-190	V
Plate Voltage.	1,4	1350	1750	V
Plate Voltage.	1,5	2600	3400	V
Useful Power Output.	1,6	3	-	kW

Note 1: With 12.6 volts rms on filament.

Note 2: With dc grid voltage of -25 volts measured from center-tap of filament supply, and dc plate voltage adjusted to give dc plate current of 0.5 ampere.

Note 3: With dc plate voltage of 4000 volts, and dc grid voltage adjusted to give dc plate current of 0.05 ampere.

Note 4: With dc grid voltage of 0 volts measured from center-tap of filament supply, and dc plate voltage adjusted to give dc plate current of 0.5 ampere.

Note 5: With dc grid voltage of -50 volts measured from center-tap of filament supply, and dc plate voltage adjusted to give dc plate current of 0.5 ampere.

Note 6: In a self-excited, coaxial, oscillator circuit and with dc plate voltage of 5000 volts, dc plate current of 1.1 amperes, grid resistor of $1500 \pm 10\%$ ohms, dc grid current of 0.250 to 0.300 ampere, and frequency of 110 Mc/s.



DIMENSIONAL OUTLINE

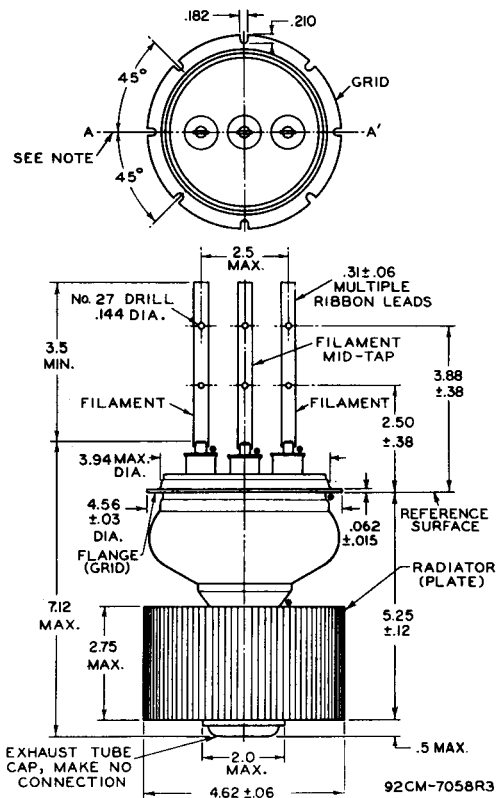

DIMENSIONS IN INCHES

• Temperature Measurement Point.

Note: Plane of filament leads will not deviate more than $3\text{-}1/2^\circ$ from plane passing through AA' normal to grid flange.

Typical Cooling Characteristics

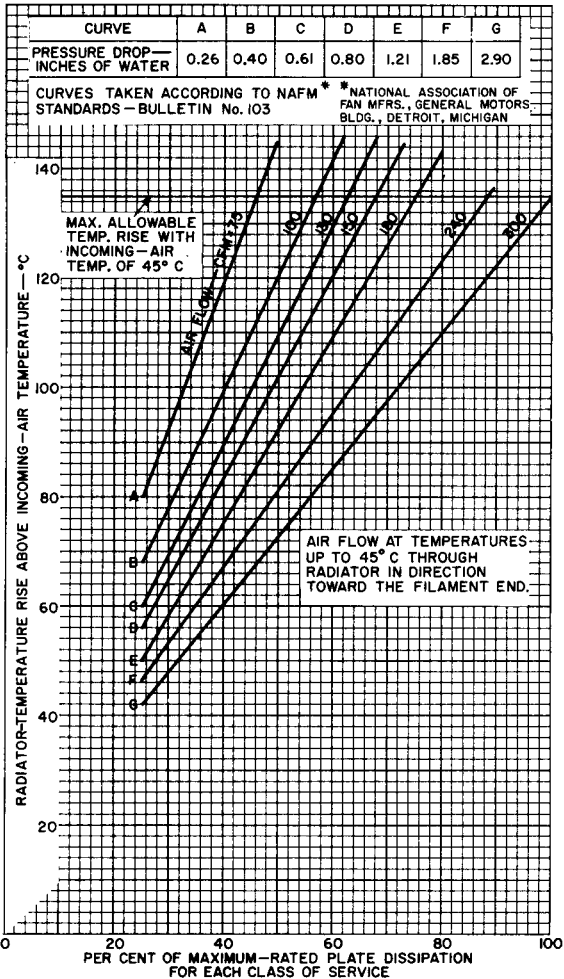

Typical Constant-Current Characteristics

