



6AG7

POWER PENTODE

SINGLE-ENDED METAL TYPE

6AG7

GENERAL DATA

Electrical:

Heater, for Unipotential Cathode:

Voltage 6.3 ac or dc volts
Current 0.65 amp

Direct Interelectrode Capacitances:

With Pin No.1 and Pin No.3 connected to Pin No.5

Grid No.1 to Plate 0.06 max. μf
Input 13 μf
Output 7.5 μf

Characteristics, Amplifier Class A1

Plate Voltage 300 volts
Grid-No.2 Voltage 150 volts
Grid-No.1 Voltage -3 volts
Peak AF Grid-No.1 Signal Voltage 3 volts
Zero-Signal DC Plate Current 30 ma
Max.-Signal DC Plate Current 30.5 ma
Zero-Signal DC Grid-No.2 Current 7 ma
Max.-Signal DC Grid-No.2 Current 9 ma
Plate Resistance (Approx.) 0.13 megohm
Transconductance 11000 μmhos
Load Resistance 10000 ohms
Total Harmonic Distortion 7 per cent
Max.-Signal Power Output 3 watts

Mechanical:

Mounting Position Any
Maximum Overall Length 3-1/4"
Seated Length 2-19/32" ± 3/32" ←
Maximum Diameter 1-5/16" ←
Bulb Metal Shell, MT-8
Base Small-Wafer Octal 8-Pin (JETEC No.88-21)
Basing Designation for BOTTOM VIEW 8Y ←

Pin 1 - Shell, Grid No.3
Pin 2 - Heater
Pin 3 - No Connection
Pin 4 - Grid No.1

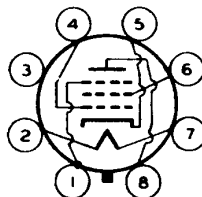

Pin 5 - Cathode
Pin 6 - Grid No.2
Pin 7 - Heater
Pin 8 - Plate

AMPLIFIER - Class A1

Maximum Ratings, Design-Center Values:

PLATE VOLTAGE 300 max. volts
GRID-No.2 (SCREEN) VOLTAGE 300 max. volts

← Indicates a change

6AG7



6AG7

POWER PENTODE

GRID-No.1 (CONTROL-GRID) VOLTAGE:		
Positive bias value	0 max.	volts
PLATE DISSIPATION	9 max.	watts
GRID-No.2 INPUT	1.5 max.	watts

→ PEAK HEATER-CATHODE VOLTAGE:		
Heater negative with respect to cathode	90 max.	volts
Heater positive with respect to cathode	90 max.	volts

**Typical Operation in 4-Mc Bandwidth Video Amplifier
Circuit of Fig. 1:**

With Grid-Resistor Bias

Used where dc restoration is accomplished in grid-No.1 circuit of the 6AG7

Plate Supply Voltage	300	volts
Grid-No.2 Voltage†	115	volts
Zero-Signal Grid-No.1 Voltage	0	volts
Grid-No.1 Resistor	0.25 to 0.5	megohm
Grid-No.1 Signal Voltage (Peak to Peak)	4	volts
Zero-Signal Plate Current	45	ma
Zero-Signal Grid-No.2 Current	13	ma
Load Resistor	3500	ohms
Voltage Output (Peak to Peak)	135	volts

With Cathode-Resistor Bias

Plate Supply Voltage	300	volts
Grid-No.2 Voltage ^o	125	volts
<i>from series resistor of</i>	25000	ohms
Grid-No.1 Voltage	-2	volts
Cathode Resistor (Bypassed with capacitor of 250 μ f, approx.)	57	ohms
Grid-No.1 Signal Voltage (Peak to Peak)	4	volts
Zero-Signal Plate Current	28	ma
Zero-Signal Grid-No.2 Current	7	ma
Load Resistor	3500	ohms
Voltage Output (Peak to Peak)	140	volts

Maximum Circuit Values:

Grid-No.1-Circuit Resistance:		
For fixed-bias operation	0.25 max.	megohm
For cathode-bias operation	1.0 max.	megohm

† obtained from supply having good regulation.

^o obtained preferably from 300-volt plate supply through resistor of value shown.

→ indicates a change



6AG7

POWER PENTODE

6AG7

Fig. 1 - Typical Video Voltage Amplifier Circuit
Having Bandwidth of 4 Mc.

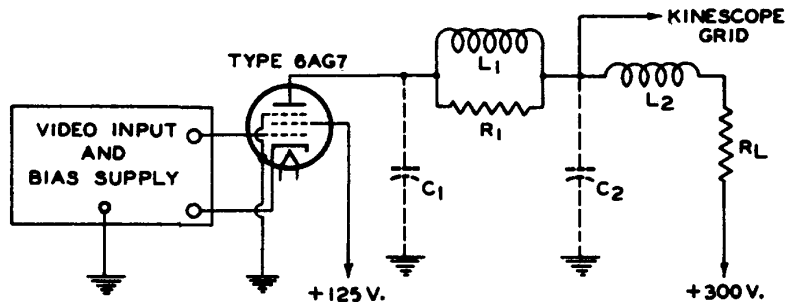

$C_1 = 9.5 \mu\mu f$ = Tube Output Capacitance + Socket Capacitance + Wiring Capacitance + Coil Capacitance

$C_2 = 19 \mu\mu f$ = Kinescope Capacitance + Socket Capacitance + Wiring Capacitance + Coil Capacitance

$L_1 = 250 \mu h$ Filter Inductor

$L_2 = 125 \mu h$ Filter Inductor

$R_1 = 20000\text{-Ohm}$, Non-Reactve Resistor

$R_L = 3500\text{-Ohm}$, 10-Watt, Non-Reactve Resistor

Devices and arrangements shown or described herein may use patents of RCA or others. Information contained herein is furnished without responsibility by RCA for its use and without prejudice to RCA's patent rights.

NOV. 1, 1952

TUBE DEPARTMENT
RADIO CORPORATION OF AMERICA, HARRISON, NEW JERSEY

DATA 2

6AG7



6AG7

AVERAGE PLATE CHARACTERISTICS WITH E_{C1} AS VARIABLE

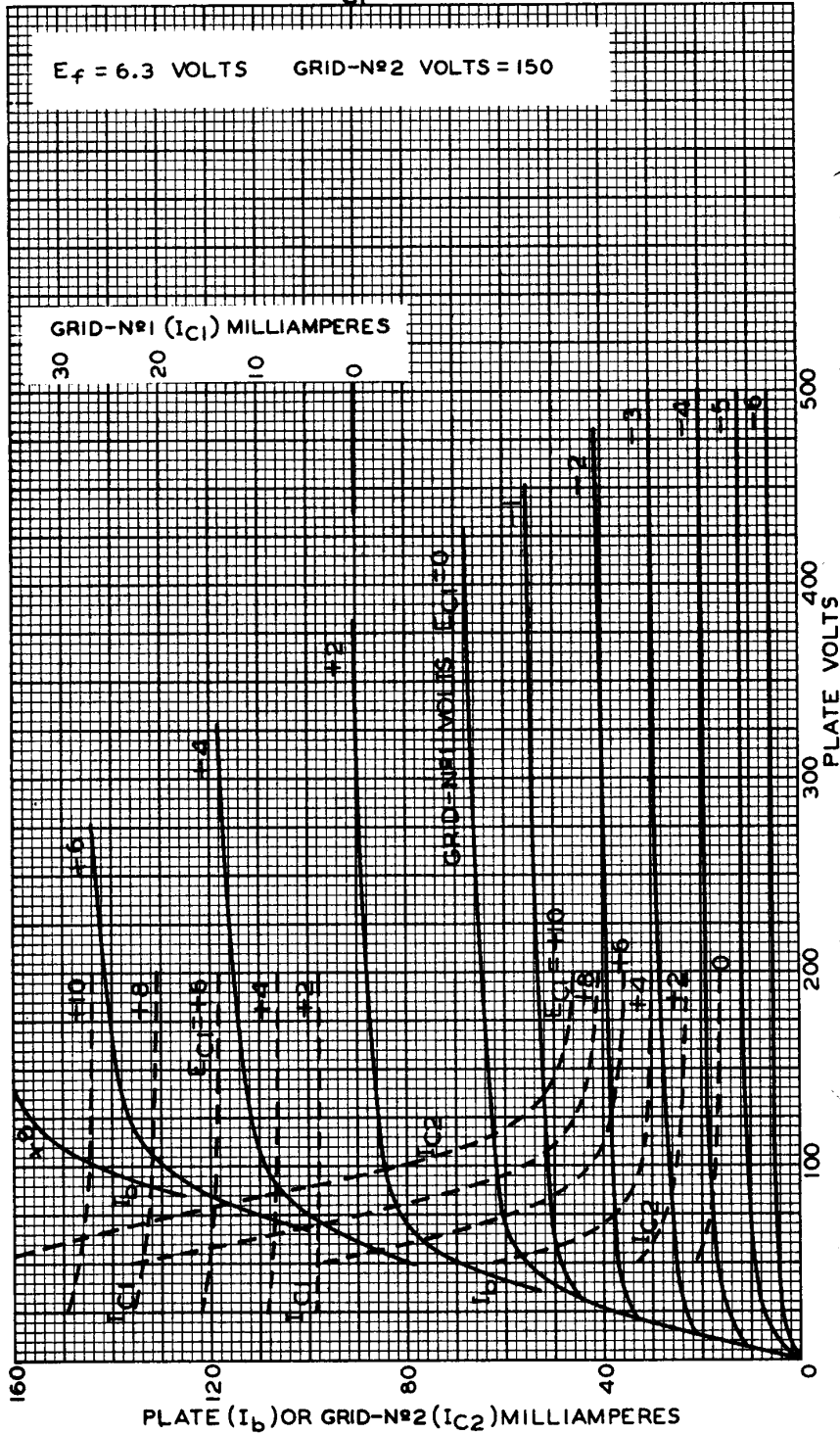

OCT. 2, 1952

TUBE DEPARTMENT
RADIO CORPORATION OF AMERICA, HARRISON, NEW JERSEY

92CM-6034R2



6AG7

POWER PENTODE

6AG7

AVERAGE PLATE CHARACTERISTICS
WITH E_{C1} AS VARIABLE

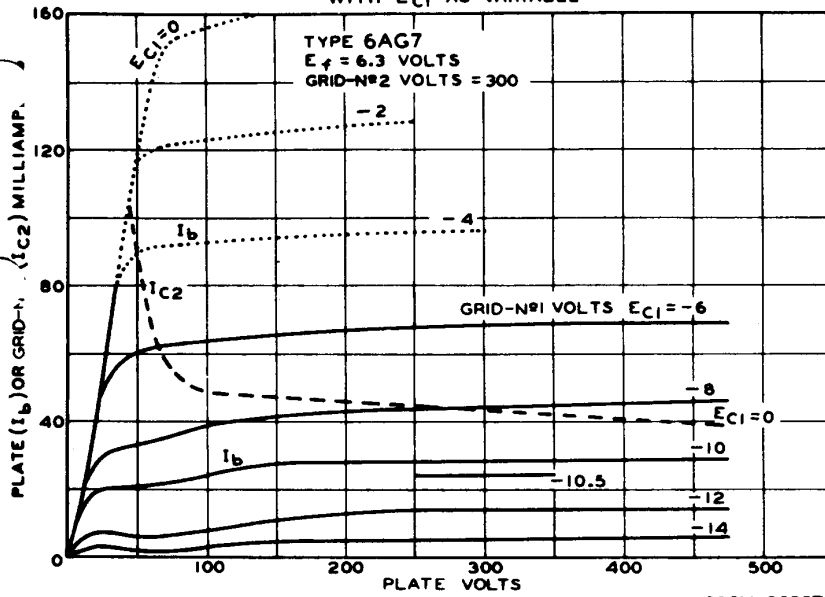

AVERAGE PLATE CHARACTERISTICS
WITH E_{C2} AS VARIABLE

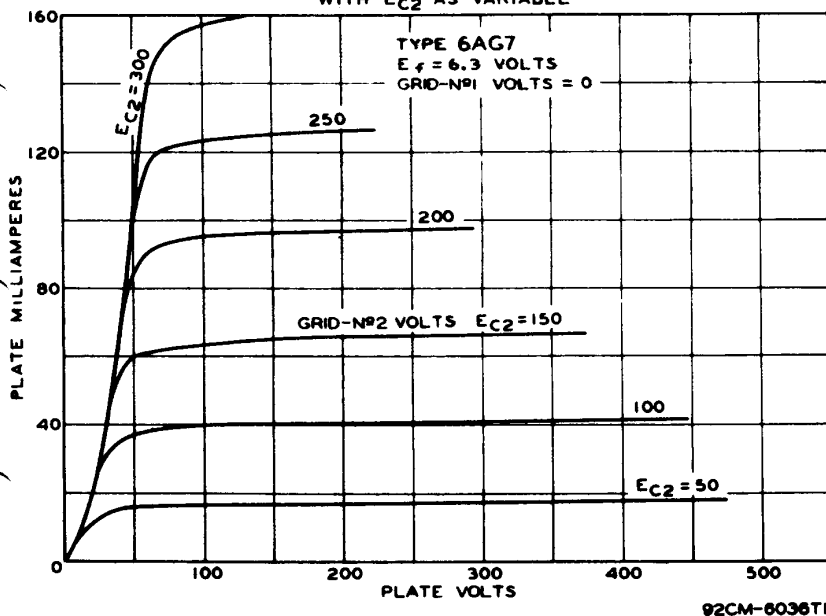

NOV. 1, 1952

TUBE DEPARTMENT
RADIO CORPORATION OF AMERICA, HARRISON, NEW JERSEY

CE-6035T1
CE-6036T1

6AG7



6AG7

POWER PENTODE

AVERAGE CHARACTERISTICS

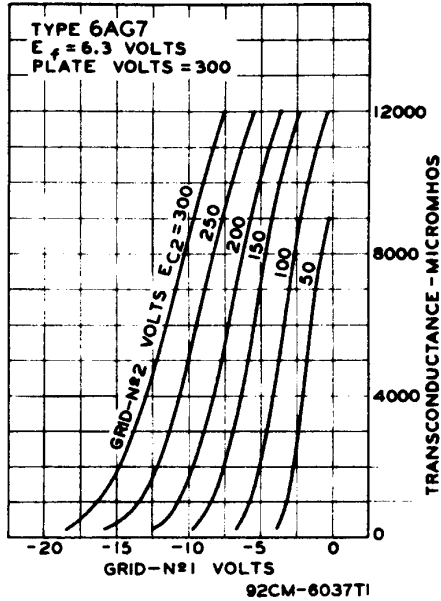

AVERAGE CHARACTERISTICS

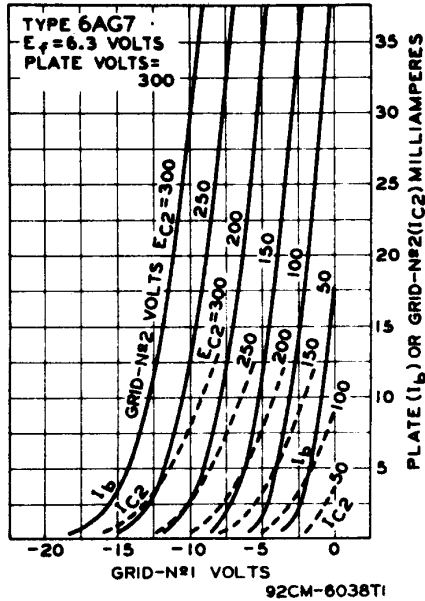

NOV. 1, 1952

TUBE DEPARTMENT
RADIO CORPORATION OF AMERICA, HARRISON, NEW JERSEY

CE-6037T1
CE-6038T1