

BEAM POWER TUBES*†

BY

O. H. SCHADE

RCA Radiotron Division, RCA Manufacturing Company, Inc.,
Harrison, N. J.

Summary—*The general characteristics of the ideal output tube for broadcast receivers are discussed briefly with respect to specific electrical and acoustical requirements.*

Considerations of practical power-tube design indicate that the tube most nearly approaching the ideal characteristics is one having an accelerating grid (screen) and a control grid which does not require power. The limitations of conventional output tetrodes and pentodes with respect to the ideal are treated and are illustrated by means of oscillograms and models showing field-potential distributions. It follows that homogeneous potential fields and directed electron beams having high electron density can be utilized to minimize these limitations. These design features indicate the feasibility of a tube suitable for operation as a class A amplifier having substantially second-harmonic distortion only and capable of high power output, high efficiency, and high power sensitivity.

The theoretically proper geometric structure for beam power tubes is developed. The theory is substantiated by performance data obtained from actual tubes.

I. INTRODUCTION

DEVELOPMENTS in the art of transmitting and reproducing sound by electrical means point toward systems of higher fidelity capable of reproducing faithfully the tremendous range of volume of the symphony orchestra without altering the infinite variety in combinations of tones and overtones. In the achievement of this ideal, radio tubes have an important part. A brief résumé of audio-frequency power-amplifier requirements will help in formulating the specifications of an ideal power tube for loud-speaker operation.

II. FUNDAMENTAL REQUIREMENTS FOR HIGH-FIDELITY SOUND REPRODUCTION

The audio-frequency amplifier in the receiving unit must cover a *frequency range* of more than eight octaves for true reproduction of music. To accomplish this, it is necessary that the amplifier tubes themselves do not generate tones of substantial magnitude within the desired range.

* Decimal classification: R330.

† Reprinted from *Proc. I.R.E.*, February, 1938.

The science of music teaches us that pure octaves, i.e., tones of second-, fourth-, and eighth-harmonic order, are always harmonious, and, therefore, are least objectionable when introduced by *harmonic distortion* in amplifiers.

The third harmonic is the octave of the pure musical "fifth." It is harmonious to single tones but causes dissonance as a harmonic of some of the component tones in musical chords of relative purity. Small magnitudes of third harmonic generated in the amplifier can be tolerated but should not exceed a few per cent of the fundamental tones. The fifth harmonic is the pure "second" to the double octave of the fundamental tone. Harmony conditions are somewhat similar to those of the third harmonic. The larger pitch difference, however, reduces masking effects¹ produced by the fundamental tones so that the permissible maximum value is considerably smaller than for the third harmonic. Higher-order harmonics of odd number, seventh, ninth, etc., are disharmonious and thus increasingly objectionable. High-order harmonics in general are so much different in pitch from the fundamental tone that magnitudes much smaller than one per cent may be noticed as a disagreeable sharpness of tone or a hissing sound. They are generated especially in amplifiers having dynamic characteristics with sudden changes of curvature.

In the preamplifier stages it is not difficult to limit harmonic distortion to satisfactory values if the required output power or voltage is substantially less than the obtainable maximum value. The output stage, however, must not only be operated efficiently but must also supply maximum power output at low distortion.

The *peak output power* required for reproduction is at least 10 to 25 times the average power output and still larger for amplifiers with volume expansion. Thus, an average volume level of one watt of electrical power demands the undistorted reproduction of peaks as high as 20 to 30 watts. If this power is to be obtained at reasonable cost, the output tube must have not only a high plate efficiency, but also a good "circuit" efficiency.

The *plate load* of the power stage is not a pure resistance. The motional impedance of commercial dynamic cone loud-speakers for receiving sets varies considerably with frequency due to the low coefficient of electromechanical coupling. Due to the loose coupling, the mechanical circuit reflects its reactance and resistance efficiently only at the resonant frequency as illustrated in Fig. 1, which shows the electrical characteristics of a typical speaker. The increase of the normal² resistance to 96.7 ohms indicates an efficiency of close to 90 per

¹ Harvey Fletcher, "Speech and Hearing," D. Van Nostrand Co., (1929).

² See 1933 Report of the Standards Committee of the I.R.E., page 36.

cent at the resonant frequency, while only about five per cent of the input power is transferred to the secondary system at other frequencies.

The reactance of the moving coil is responsible for the normal impedance rise at high frequencies. This impedance rise is quite easily corrected over the entire *high-frequency* range by the much-used series-resistance-capacitance shunt on the reflected load. This compensation is absolutely necessary to provide good quality and to avoid high transient voltages when the output tubes have high internal impedance (r_p), but it may be omitted with low-impedance tubes.

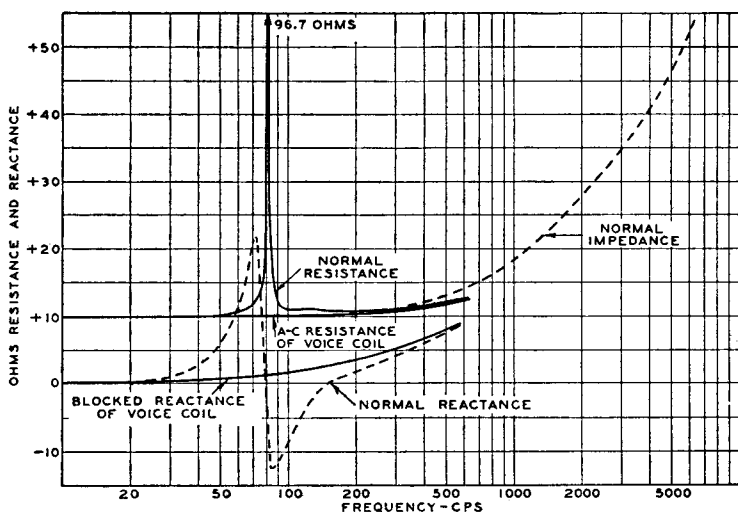

Fig. 1—Electrical characteristics of a dynamic loud-speaker.

Loud-Speaker Damping

The internal impedance of the power tube shunts the plate load. If the plate load (R_p) is high compared to the tube impedance, the Q ratio of a parallel-tuned plate load is decreased by the tube shunt which acts to prevent a large resonance rise. The mechanical resonance of the dynamic speaker appears over a short frequency range in the primary substantially as a high-impedance parallel-tuned circuit (compare Fig. 1). This circuit is damped by low-impedance tubes but affected little by high-impedance tubes. But even if the reflected electrical circuit resonance is almost completely damped by low tube impedance, the sound output still rises above normal due to the high energy transfer into the mechanically resonant secondary circuit.

If a resonant-voltage rise of 5 on the voice coil is assumed and the equivalent increase in efficiency is considered as from 5 to 81 per cent, a calculation yields the following results: High-impedance sources as

represented by pentodes in class A service with $r_p = 10R_p$ permit a 16.4-decibel sound-output rise at resonance; triodes with $r_p = \frac{1}{2}R_p$, a 7.8-decibel rise. For $r_p = 0$, the rise is still 5.1 decibels.

Electrical damping cannot completely eliminate resonance "boom" and prevent overload of the speaker at resonance. This must be done by power-absorbing circuits or in the loud-speaker design.

III. GENERAL PROBLEM OF POWER-TUBE DESIGN

The design of a desirable tube begins with the formulation of ideal-type characteristics. An analysis of the electrical characteristics of an idealized tube follows in order that the most suitable design principle may be selected on the basis of both tube development and practical operation. The theoretical investigation of the electrical principles involved points out the direction of research, and assists in formulating the specific design problem.

According to the preceding discussion, the general specifications for an ideal power tube are as follows:

A. General Specifications for an Ideal Power Tube

1. *Low distortion* mostly of second-harmonic order. A small percentage of third harmonic can be tolerated. Higher-order harmonics must be negligible.

2. *Good power sensitivity* to permit low-level operation of the pre-amplifier stage.

3. *High power output* obtainable with self-bias and supply circuits having the voltage regulation of conventional broadcast receivers. Exceptionally large power output with good quality for limited high-frequency response with supply circuits of moderately good regulation.

4. *Maximum efficiency* in both tube and associated circuits with respect to power dissipation as well as cost.

5. *Effective damping* of resonant loads.

B. Analysis of Tube Types and Design Possibilities on the Basis of the Required Electrical Characteristics

1. Triodes

(a) The Required Characteristic for Negative-Control-Grid Operation

The distortion from present class A output triodes is low and contains only small magnitudes of higher-order harmonics. The 2A3 is a large power triode for receivers. It is a filament type, having a large effective cathode area which does not require as much heater power as a unipotential cathode of equivalent area. However, it is not feasible at present to construct at reasonable cost a triode having much higher

power sensitivity, higher efficiency, and larger power output than the 2A3 for a 300- or 400-volt plate supply. The necessary large cathode area would be quite expensive and would present difficult constructional and operating problems due to grid emission. The relatively low efficiency of low- μ class A triodes is a serious objection from the standpoint of tube dissipation, and cost of power supply for increased output power.

A plate efficiency approaching 50 per cent without grid current in class A service is not impossible even for existing triodes, but the power output for medium voltages is very small with respect to the size of the tube. The *hypothetical* triode must have a sharp cutoff, substantially constant μ at all plate voltages, and high transconductance,

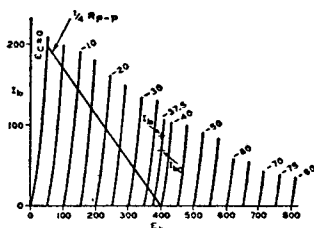

Fig. 2—Plate family of hypothetical triode.

Conditions for push-pull operation

$E_c = -37.5$ volts fixed

$E_b = 400$ volts fixed

$I_{b0} = 71$ milliamperes

$I_b = 85$ milliamperes

Power output = 35 watts (two tubes)

Efficiency ≈ 51.2 per cent

R_{p-p} = plate-to-plate load

i.e., a very steep rise of current versus applied potential, as shown in Fig. 2. This plate characteristic is ideal on a theoretical basis. The characteristic family is constructed by parallel displacement of the zero-bias characteristic. This constant μ (it is shown to be 10) is approached in an actual tube by using a fine-mesh control grid at relatively large distances from cathode and plate. The effective grid potential at $E_b = +50$ volts and $E_c = 0$ volts is thus approximately five volts, which must be sufficient to cause an electron current of 200 milliamperes. We know that this is possible only by the use of a *very large cathode area* even for considerably lower μ values. Furthermore, this large cathode should radiate little heat to the grid in order to avoid grid emission.

A cathode of large area may be produced with an auxiliary positive grid. The "virtual cathode" of the space-charge-grid tube seems a good solution. The virtual cathode, however, must have an *electron reserve capable of supplying the peak current* demanded from it. The space-

charge-grid tube thus requires a larger cathode current and consequently a larger B power supply in comparison with other tubes to be discussed and, therefore, does not meet the requirements for circuit efficiency.

(b) Triodes with Positive-Grid Operation

The control grid itself may be permitted to swing positive, in order to accelerate the electrons and obtain a steep current rise at low plate voltages. This method has certain disadvantages. The grid current in conventional triodes is of substantial magnitude and considerably decreases the expected plate-current rise, especially at low plate voltages.

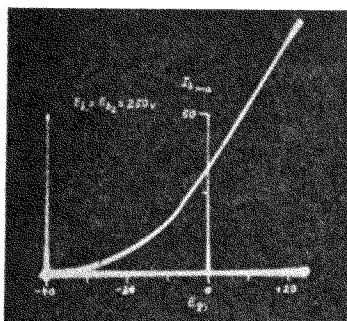

Fig. 3—Transfer characteristic of a positive-operated-grid output tube with conductively coupled driver.

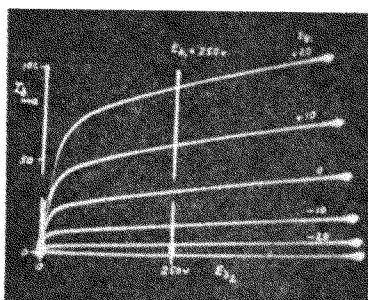

Fig. 4—Resultant plate family of a positive-operated-grid output tube with conductively coupled driver.

This action causes increased distortion. A second complication arises from the fact that there are now two positive electrodes in the tube so that secondary electrons from one electrode may not fall back to the plate but instead may travel to the other positive electrode.

Secondary emission occurs whenever electrons hit an obstacle which, aside from transit-time effects, must be at positive potential. The liberation of normal³ secondaries begins substantially at a positive voltage of about ten volts and thus causes a break in the grid-current curve. The performance of present-day class B triodes shows fairly good success in smoothing out the grid-current "kinks" in their reaction on the plate current, by bettering the ratio of plate current to grid current through the use of specially designed high-impedance triodes. These high-impedance tubes have a plate family very similar to pentodes and thus give a performance similar to a pentode. Unlike the pentode, they require driving power and, therefore, demand care-

³ H. Barkhausen, "Electronenroehren," vol. 1.

fully designed low-impedance preamplifiers. Because only drivers with zero internal resistance and ideal coupling devices eliminate grid-circuit distortion, the "kinks" and consequent higher-order harmonics cannot be completely suppressed in practical systems. That this is the case is shown by the transfer characteristic of Fig. 3. The plate load has little effect on the break in the characteristic.

In push-pull operation, tubes with positive grids operate with considerable plate efficiency. They may be designed to require no biasing voltage. The *distortion* of high-impedance triodes operating with positive grid voltages is naturally higher than that of pentodes operated without control-grid current, because distortion is increased in all

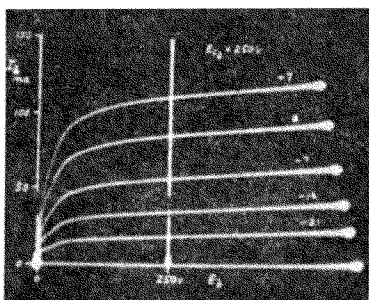

Fig. 5—Plate family of a typical power pentode.

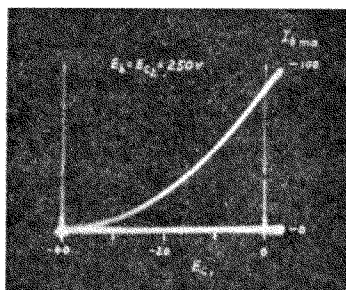

Fig. 6—Transfer characteristic of a typical power pentode.

practical cases by harmonics including those of high orders arising from the irregularities of the grid-current characteristic.

In class A operation, single high-impedance tubes operated with positive control-grid voltages and conductively coupled driver stages present no advantage in output performance over conventional pentodes. The resultant plate family is very similar to that of a pentode and consequently the plate-circuit performance with regard to distortion, efficiency, and load variation is also similar (Figs. 4 and 5). The transfer characteristic of pentodes operated without grid current is inherently a smooth curve (Fig. 6).

2. Pentodes

(a) Characteristics of Conventional Pentodes

Power output and efficiency of commercial pentodes are considerably higher than those of conventional triodes operated without grid power. The screen-grid potential remains fixed and highly positive at all plate-voltage values. This feature eliminates the necessity of a large cathode area for obtaining a steep plate-current rise with low

plate potentials. *Overbiased pentodes* in push-pull operate with an overall efficiency which compares favorably with that of good class B triodes, and in addition have the considerable advantage of operating without grid current. This guarantees negligible high-order harmonics and a simple preamplifier design.

It can be shown that *overbiased operation* of push-pull pentodes is, in fact, *necessary* in order to obtain distortion values of less than three per cent consisting mainly of third-harmonic distortion and having less than one per cent of fifth harmonic. The attainment of a high plate efficiency of 70 per cent and a total B supply power efficiency of approximately 60 per cent are accompanied by considerable increases in the current demand for an applied signal. In order to maintain correct operating conditions for all signal levels, it is necessary to provide a well-regulated bias and B voltage supply. A study of modern receivers shows, however, that the power stage is generally designed to have at most a two-to-one increase in plate current due to a signal and is operated with self-bias or semi-self-bias. In many instances better performance with respect to distortion and efficiency is sacrificed to obtain partial class A performance and with it supply circuits not requiring good regulation.

It has been indicated that the desirable power tube could not be built economically as a triode, because three-electrode tubes with positive signal grids were ruled out for distortion reasons. It will also be shown later that the operation of triodes having high power sensitivity places severe requirements on the circuit. Because of these limitations the solution will be sought in a four- or five-electrode tube having a separate positive accelerating grid.

(b) Characteristics of a Desirable Power Pentode or Tetrode

The first requirement in our specifications for an ideal power tube is *low distortion of substantially second-harmonic order*. The practical solution is a square-law curvature of the transfer characteristic and a plate family which is substantially linear over the entire useful plate-current—plate-voltage characteristic.

The second requirement is *good power sensitivity*. This demands fine-mesh grids, and an efficient cathode with close control-grid spacing to obtain high transconductance.

The third and fourth requirements are *high power output and efficiency*. These require the extension of the straight section of the plate family down to very low plate-voltage values and a low percentage of screen-grid current at all plate voltages in the useful range.

The fifth requirement is *low plate impedance*. This is in conflict with the second, third, and fourth requirements. The screen-current rise

with decreasing plate voltage is considerably larger in pentodes or tetrodes of low plate impedance than in pentodes with high plate impedance whether the curves are ideally straight or not, provided good screening of the plate field with resultant good cutoff is maintained. The large increase of screen-grid dissipation with signal in low-impedance pentodes decreases efficiency and power-output capability, while the plate impedance obtainable is hardly low enough to effect a substantial damping of a resonant load.

It is, therefore, reasonable to depart in this one point from the ideal if a power tube can be designed which satisfies all other requirements. It will be shown later that the characteristic of such a tube can be changed into that of a very good low-impedance triode by the use of an inexpensive circuit.

An analysis of screen-grid tubes with respect to potential conditions encountered by electrons in their flight is necessary to recognize limitations in existing tubes. It will be shown that these limitations can be overcome by directed electron beams.

IV. ANALYSIS OF SCREEN-GRID TUBES—ESPECIALLY THE ELECTRON CURRENT IN SPACE BETWEEN ACCELERATING GRID AND PLATE

A. Effect of Space Charge

(1) *Space-Charge Effects in Diodes*

Let us assume a parallel-plane diode for the purpose of illustrating electron effects in space. Without the presence of electrons, the potential between cathode and plate increases linearly with distance (Fig. 7). This constant gradient is changed if electrons are present. The effect of the negative charge of electrons in space, the "space charge," is to reduce the space potential. Because the density of electrons in a given current is inversely proportional to their velocity, the *potential gradient* is thus zero at the cathode if the initial velocity of the electrons is neglected, and increases cumulatively with distance. An increasing number of *secondary electrons* are liberated at the plate at plate voltages over ten volts approximately. These electrons fly back a short distance towards the cathode but as their volt-velocity is much smaller than that of the primary electrons, they soon come to a stop and return to the plate. The plate current is thus not affected directly. A noticeable decrease in plate current may, however, be caused by an increased space-charge density in the space $X-P$ (Fig. 7) due to secondary space charge in cases of large secondary emission.

2. Space-Charge Effects in Tubes with Accelerating Grid

The potential distribution in a triode with positive grid and plate is shown in Fig. 8 for the theoretical case of uniform electron velocity, uniform path length, and the absence of secondary emission. We as-

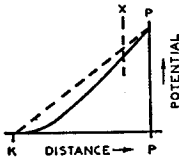

Fig. 7—Effect of space charge on potential distribution in a diode.

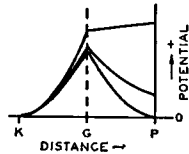

Fig. 8—Potential distribution in a tube with positive grid and plate.

sume again a parallel-plane structure and also low current absorption by the fine-mesh grid in both directions. For a distance $d_{K-G} = d_{G-P}$ and zero plate voltage, the potential distribution is symmetrical on both sides of the positive grid. The electrons just reach the plate because they are decelerated to zero velocity at zero voltage and zero gradient. More positive plate voltages change potential distribution and gradients as indicated. This will be discussed in more detail later on. All electrons passing the grid reach the positive plate.

The *theoretical tetrode* having a control grid inserted between cathode and screen grid should thus have the desired plate characteristic

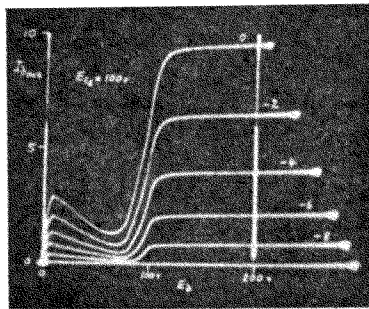

Fig. 9—Plate family of a typical tetrode with low space-charge density.

of parallel straight lines, the plate current rising abruptly at zero plate voltage to a value constant for all positive plate voltages.

In the practical case, however, *secondary electrons* are liberated at the plate and find a positive gradient in the direction of the screen grid at all plate voltages substantially lower than the screen-grid voltage (see Fig. 8). The secondaries thus fly to the screen grid. This action decreases the plate current and increases the screen current.

As the number reaching the plate decreases at very low plate voltages, the well-known plate-current curve shown in Fig. 9 is obtained. Note the plate voltage at which substantial secondary emission begins.

B. The Suppression of Secondary-Emission Effects and the Suppressor Grid

The tetrode characteristic of Fig. 9 will approach the ideal characteristic if it is possible to prevent secondary emission or to suppress its effects. Most secondary electrons have a relatively low velocity of emission. They are forced to return to the plate if the potential between the positive grid and the plate is decreased at some point ap-

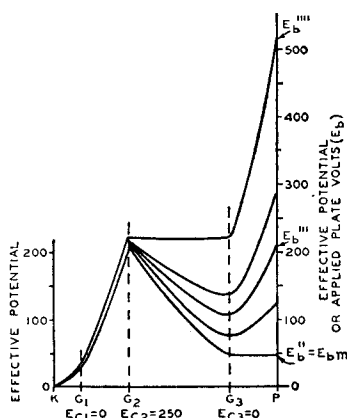

Fig. 10—Calculated effective potentials in a typical power pentode.

proximately ten to twenty volts below the plate voltage. Such a potential “minimum” will prevent the large loss of plate current due to secondary electrons. It can be produced by insertion of a low-potential electrode, the “*suppressor*” grid in pentodes.

As illustrated in Fig. 10, a potential minimum is formed for plate voltages higher than E_{bm} . This forces secondary electrons back to the plate. The percentage of primary electrons arriving at the plate is found, however, to decrease considerably in actual tubes when the plate potential is decreased to the value E_{bm} . This plate-current loss is caused partly by the *nonuniform potential* in the plane of the suppressor grid G_3 . The wires of G_3 are always at zero potential while only the space between wires have a positive potential of varying magnitude caused by the penetrating positive screen-grid and plate fields. This “bumpy” field causes the value E_{bm} to represent a range of voltages instead of a single value and thus rounds off the theoretical sharp knee at E_{bm} .

The plate-current loss at low voltages is caused by *velocity differences of electrons in the normal direction* produced mainly by distortion of the potential field due to grid wires, side rods, and nonuniform distances of electrodes. Such velocity differences between screen and plate result in oversuppression in some sections in the plate-current path, while secondaries are just sufficiently suppressed in other sections.

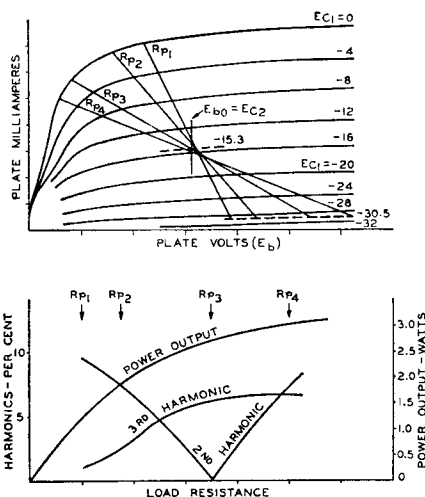

Fig. 11—Performance characteristics of a typical power pentode.

C. Pentode Performance Resulting from Nonuniform Potential Distribution

The round "knee" of the plate-current characteristic of conventional pentodes produces in class A operation the distortion-versus-load characteristic shown in Fig. 11. With low loads (R_{p1} and R_{p2}) the distortion is mainly of second-harmonic order but the plate efficiency is low. Higher loads give better efficiency but cause a relatively large third-harmonic distortion. Components of higher order are small for reasons discussed later.

From the standpoint of distortion, operation with a low plate load is much preferred. Although the percentage of the second harmonic is large in single-tube operation, it is much less objectionable than a considerably smaller percentage of third-harmonic distortion. It is difficult by comparison with speech or music to detect a difference in quality of sound output between tubes having five and ten per cent second-harmonic distortion.

In push-pull operation, even harmonics generated in each power

tube cancel; odd harmonics do not cancel. Odd harmonics may be reduced by the loading conditions made possible in class AB operation.

D. Current Distribution as a Function of the Potential Field Between Screen and Plate

1. The Potential Field

We now investigate the causes of the plate-current loss in pentodes at plate voltages lower than the screen-grid voltage. The field between

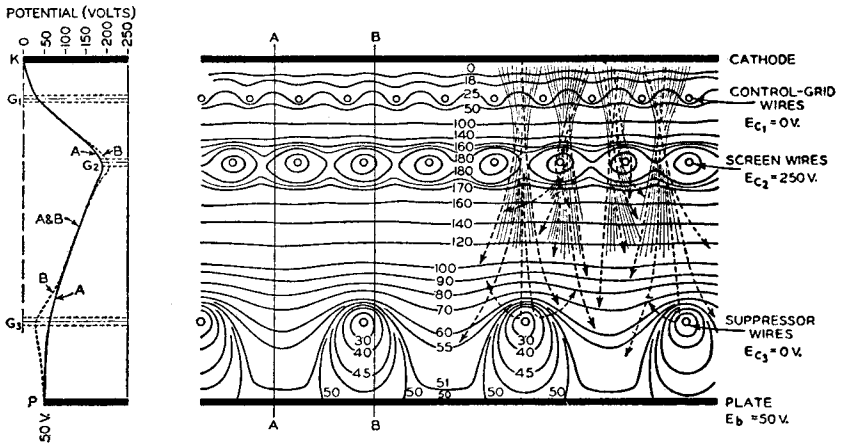

Fig. 12—Plot of potential distribution in a typical power pentode.

screen grid and plate is a decelerating field at medium and low plate voltages. The percentages of electrons arriving at the plate out of the total number which leave the cathode is a function of the shape of the potential field in the tube which determines the electron path and velocity component in the direction of the plate. According to Fig. 10, the entire electron current passing the screen-grid wires should reach the plate for the condition when $E_b > E_{bm}$, but this is only true if the potential field is homogeneous and only for electrons having a normal direction and equal velocities. The actual potential field of a pentode at $E_b = E_{bm} = 50$ volts is shown in Fig. 12. The field is obviously not uniform. The wires of the grids in the tube disturb the homogeneity of the field.

The action of electrons in this field can be mechanically illustrated by means of the topographic model shown in Fig. 13. In this model, the electrostatic force is replaced by a component of gravitational force depending on the slope of the model at any particular point. The slope is analogous to the potential gradient of the electrostatic field (see left side of Fig. 12). Each lamination represents a potential

step of ten volts, the lower levels corresponding to more positive potentials. The No. 1 and No. 3 grid wires are thus mountain peaks. The electrons may be compared to frictionless balls rolling down from the elevation of the cathode (zero volts) into the valley of the screen grid (+200 to +250 volts). A certain percentage missing the wires of G_2 (the holes) are carried by their momentum up the incline to the plate. Those that pass near the center between screen-grid wires follow a fairly straight path toward the plate. Some of them, are, however, diverted by the curved contour of the suppressor-grid hills, lose velocity and return in an arc toward the screen-grid valley; others traverse the gap between the suppressor hills and reach the plate on the other side.

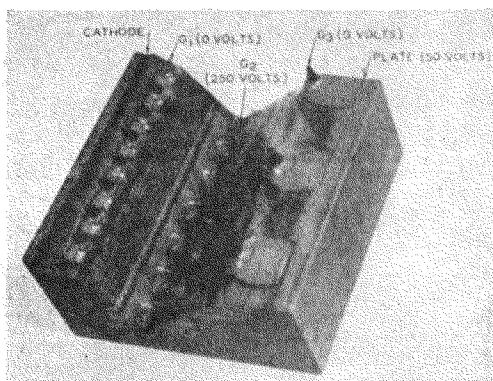

Fig. 13—Topographic model of potential distribution shown in Fig. 12.

A number of the balls coming from the cathode pass close to the screen-grid "holes," and thus are deflected from a straight path because they obtain a tangential-velocity component in the conical field near the screen-grid wires. Their chances of reaching the plate are less than for balls rolling in a straight path toward the suppressor-grid hills. A certain percentage of electrons is headed directly toward the screen-grid holes and does not get through at all. Neglecting this percentage at present, it is easily understood from the analogy that the number of electrons reaching the plate increases when the "gap" between the suppressor-grid hills is deepened by lowering the elevation of the plate because fewer electrons are turned back to the screen grid. Electrically, the gap between the suppressor wires is deepened by an increase of plate potential. The steepness of the current rise with plate voltage thus depends on the manner in which the gap width, i.e., the shape and gradient of the decelerating potential field, affects the tan-

gential component of electrons. As pointed out later, the actual potential distribution may be altered considerably by space charge which is neglected in this model.

The plate current is thus a function of the potential distribution between screen grid and plate within the range of decelerating potentials. Fig. 14(a) shows the plate current of a pentode plotted against the square root of the plate voltage. The curve has several linear sections and shows four significant plate-voltage values at which the factor of proportionality for current increments changes. Calculation of resultant potentials in the planes of the various electrodes disclosed that *significant potential-field or gradient changes* occur between screen grid and plate at the values $E_b = E''$, E''' , and E'''' , indicated in Fig. 10.

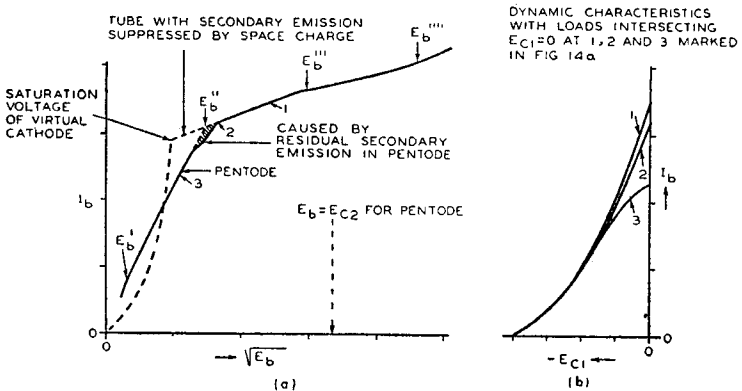

Fig. 14

- (a)—Proportionality of current increments to the square root of plate voltage between successive group-saturation values in a typical power pentode.
 (b)—Dynamic characteristics of a typical power pentode with loads intersecting $E_{c1} = 0$ at points 1, 2, and 3 marked in (a).

We term these specific values "group-saturation" voltages, as certain groups of electrons have then arrived at the plate.

2. Group-Saturation Potentials

At $E_b = E_b'$ only the electrons following a normal path have reached the plate.

At $E_b = E_b''$ the potential line of plate-voltage value has just penetrated completely between the suppressor wires, and has touched the plate. This occurs quite suddenly as observed in the electrolytic tank (compare Fig. 12). The average field gradient between G_3 and plate has become zero. At plate voltages $E_b > E_b''$, the field between plate and G_3 becomes accelerating

At $E_b = E_b''$, the acceleration in the plate field has become equal in magnitude to the deceleration in the screen-grid field.⁴

The fourth and less distinct group-saturation value occurs when the penetrating plate-potential line extends as far as the screen grid. This is the case at $E_b = E_b'''$; the entire field between G_2 and plate has become accelerating so that no electrons are returning to the screen. The partial saturation voltages are easily expressed in terms of electrode potentials and forward- and reverse- μ values.

The apparent *one-half-power proportionality of current increments* to the plate voltage observed in three sections of the $I_b - E_b$ characteristic is of particular interest. The electron "spray" in the decelerating suppressor field is caused by tangential-velocity components (compare Fig. 12). The deflecting force on electrons of given velocity having a tangential component decreases proportionately to the decelerating gradient.

The effective area enclosed by a penetrating potential line in and close to the plane of grids increases over a considerable voltage range substantially proportional to the one-half power of the voltage applied to the source or sources of the potential line. In the considered case the applied voltages E_{c1} , E_{c2} , and E_{c3} are constant and the decelerating field is controlled by the plate voltage. Thus, $\Delta i_p = KE_b^{1/2}$. The factor K changes its magnitude at every partial saturation point.

Under *dynamic conditions*, the potential fields on each side of the screen grid are controlled by two respective voltages. Grid voltage and plate voltage vary with opposite signs. The plate-current increases with the three-halves or four-halves power of the grid voltage and approximately with the minus one-half power of the plate voltage (decreasing). As the plate-load value governs the plate-voltage change, it is possible to obtain sections with three-halves-, two-halves-, or one-half-power increments of current in the decreasing plate-voltage range as shown by the dynamic curves in Fig. 14(b). Due to this fact, pentodes are substantially free from high-order harmonic distortion when loaded properly.

E. Effects of Space Charge Between Screen and Plate of Power Pentodes

If the mesh of the suppressor grid G_3 is made very fine (oversuppression), the plate current is decreased considerably at lower plate

⁴ The value of E_b'' was found to be approximately equal to the effective screen-grid potential in a number of pentodes. In tetrodes the minimum occurs in the center of the space between the screen grid and plate at $E_b = P_{c2}$. In pentodes, it does not necessarily occur in the plane of G_3 due to space-charge effects which thus affect the value of E_b'' .

voltages due to the low effective positive potential and its area in the plane of G_3 (a high μ -factor of the suppressor in both directions causes low plate impedance in the decelerating potential range). With a suppressor of coarser mesh, the effective positive potential area is increased and, consequently, the plate current and plate impedance are increased at low plate voltages. At the same time, however, the range E_p' to E_p'' in which secondary-emission effects occur is moved to higher plate voltages and the potential minimum is reduced. The mesh of G_3 is adjusted in practice so as just to eliminate secondary-emission effects under normal cathode-operating conditions (Fig. 5). The same tube, however, shows larger secondary-emission effects (under suppression) if operated with a temperature-limited (underheated) cathode as shown in Fig. 15. This points out that *the electron*

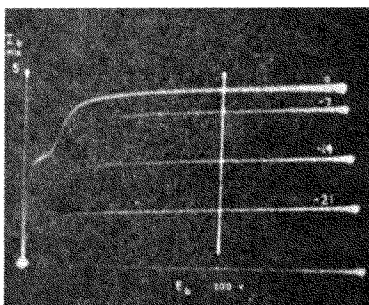

Fig. 15—Plate characteristics of typical power pentode operated with temperature-limited cathode ($E_f = 0.4$ normal volt).

space charge near and between the grid wires of G_3 under normal conditions reduces the space potential and *contributes to the suppression of secondary-emission effects*.

If the electron density is further increased, it does by itself become sufficiently large to produce a minimum potential in space between plate and screen, and thus suppresses secondary-emission effects without the help of a physical low potential source.

When the suppressor grid is replaced by space charge, the potential gradient at and in the direction of the plate never becomes negative in correctly designed tubes; thus, the curved section between E_b' and E_b'' is eliminated as indicated by dashed lines in Fig. 14(a).⁵

⁵ Some development work on replacement of the suppressor grid by space charge has been done in Europe, especially by Electric and Musical Industries, Ltd., in England. They have worked on tubes in which the suppression of secondary-emission effects is accomplished by space charge.

V. THEORY AND DESIGN OF BEAM POWER TUBES WITH SPACE-CHARGE SUPPRESSION OF SECONDARY-EMISSION EFFECTS

A. Plate-Current Characteristics of Tetrodes with Potential Minimum

Potential conditions in a decelerating field have been treated in a paper by Fritz Below.⁶ The theory applies with modifications to the screen-plate section in tetrodes and pentodes, where we are interested especially in a definite and low saturation potential. Space-charge conditions at higher plate voltages are of equal importance in the design of power tubes. We shall thus examine the potential distribution in space with this specific purpose in mind.

1. The Potential Minimum in Space

The space-charge density in a given electron current depends on the cross section of the electron path and the electron velocity. The potential distribution in space between positive grid and plate varies with distance as shown in Fig. 16(a). There are assumed constant cross section, constant current, and fixed electrode potentials as shown. The transit time of each electron is increased with greater distance between electrodes; hence, the number of electrons in the space between grid and plate is also increased and, consequently, the total negative electron charge which reduces the space potential. In the illustrated case the potential gradient at the plate becomes zero for $d = d_2$. For distances greater than d_2 , a potential minimum is formed near the plate; the potential gradient at the plate has reversed sign and the field at the plate accelerates primary electrons. For the still larger plate distance d_4 the potential value at the minimum M has decreased to zero.

The theoretical minimum distance d_{G-P} for the existence of a potential minimum at zero value in the ideal parallel-plane triode is equal to the cathode-grid distance, as illustrated in Fig. 8. It is seen that the minimum of zero value occurs at zero plate voltage and that no potential minimum is formed at low positive plate voltages. Hence, this distance is too short for suppression of secondary-electron effects.

The potential distribution with greater plate distances for a given current is shown versus plate voltage in Figs. 16(b) and 16(c). The minimum of zero value forms at $E_b = E_m$. Sufficient potential minima of positive value for suppressor purposes are produced with plate potentials having values between E_m and E_{b1} . For the shorter distance (Fig. 16(b)), the value E_{b1} is lower in potential than the accelerating-grid potential. The potential difference between plate and minimum is insufficient to repel secondary electrons from the plate for voltages be-

⁶ "The theory of space-charge grid tubes," *Zeit. für Fernmeldetechn.*, vol. 9, pp. 113-118; August 29, (1928).

tween⁷ E_{b1} and E_{b2} . Secondary-electron effects are thus to be expected in this plate-voltage range, and are indicated in the corresponding plate characteristic. For the larger distance (Fig. 16(c)) a larger minimum of positive value is formed up to plate potentials higher than the accelerating-grid potential. The minimum potential in this case remains sufficiently lower with respect to the plate voltage to repel secondary electrons liberated at the plate.

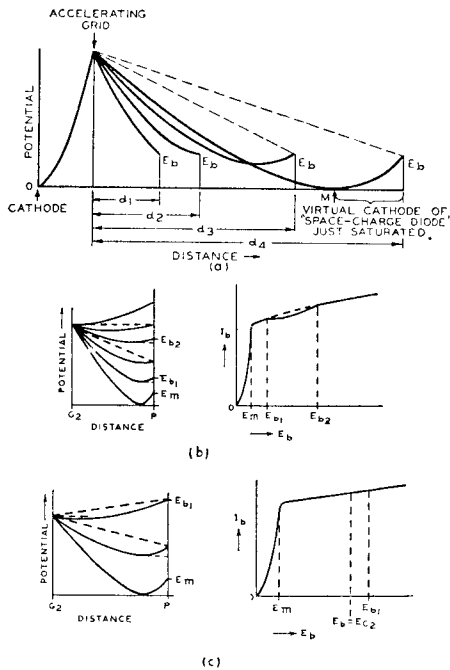

Fig. 16

- (a)—Potential distribution in space between accelerating grid and plate as a function of the distance between them (constant current to accelerating grid).
 (b)—Plate current and space potential between accelerating grid and plate as a function of plate voltage for conditions where insufficient minima are formed.
 (c)—Same as for (b), but for conditions where sufficient minima are formed.

Hence, the minimum plate distance for good suppressor action by the space charge is the distance for which the potential minimum remains at least ten to twenty volts lower than the plate potential. The minimum ratio of screen-plate distance to screen-cathode distance is $\rho m = d_{g-p}/d_{g-k}$. This ratio is considerably larger than unity for struc-

⁷ B. Salzberg and A. V. Haeff, "Effects of space charge in the grid-anode region of vacuum tubes," *RCA Rev.*, vol. 2, pp. 336-374; January, (1938).

tures with parallel or divergent electron beams, i.e., constant or increasing electron-path cross section in the direction of the plate. The actual value of ρm depends on the electron density; hence, ρm is larger for a larger angle of divergence and also larger for smaller values of plate current. In the equivalent triode, the ratio of ρm , therefore, does not have one fixed value because it is a function of potentials and current. In the beam power tube, the *optimum* distance ratio has the value 2.9.

2. The Virtual Cathode

Assume that a constant supply of electrons having uniform velocity and perpendicular direction is maintained through a fine-mesh accelerating grid. All of these electrons reach the plate for voltages $E_b > E_m$: the primary electron plate current is constant. The plate saturation current may be decreased by a secondary-electron current in cases of insufficient potential minimum in space (Fig. 16(b)). In practical cases the electron supply to the screen increases with plate voltage, and causes a characteristic of finite impedance value for $E_b > E_{bm}$.

At $E_b = E_{bm}$, the electrons are just decelerated to zero velocity at zero potential. The condition in space at M (Fig. 16(a)) is termed "virtual cathode" as it has the criteria of a real cathode, i.e., zero potential and zero electron velocity. The virtual cathode is saturated and disappears at E_{bm} because the positive value of M for $E_b > E_m$ indicates a finite velocity of all electrons which are able, therefore, to reach the plate.

A decrease in plate voltage to $E_b < E_m$ seems to require a potential minimum of negative value. For zero electron velocity of emission at the real cathode, a minimum of negative value would stop the entire electron current to the plate; but electrons of zero initial velocity cannot form a space charge of negative potential value. The condition $M = 0$ at $E_b < E_m$ can exist, however, for a lower plate current. The excess electrons at the virtual cathode are forced to return to the accelerating grid and increase the space charge between M and the screen grid. The consequent decrease in space potential causes the virtual cathode to recede from the plate. The plate current is space-charge limited in the voltage range $E_b < E_m$.

We are justified in treating the section consisting of virtual cathode and plate as a diode and in drawing the following conclusions:

- i. The steepness of the diode-current (plate-current) rise with plate voltage depends on the area of the virtual cathode and its distance from the plate. Close spacing or a large area of the virtual

diode causes high conductance with consequent low saturation potential, i.e., a "knee" of the plate-current curve at a low plate voltage.

ii. If a sharp knee is desired, the virtual cathode must saturate at a single plate-voltage value over its entire area. This requires uniform distance from the plate, as well as uniform density and velocity of all electrons forming the virtual cathode.

iii. The plate current is space-charge limited for plate voltages lower than the value necessary to saturate the virtual cathode and thus cause its disappearance.

(a) Virtual-Diode Spacing and Saturation Voltage E_m —Functions of Electrode Voltages

The electron supply to the virtual cathode can be varied in tetrodes by the control-grid voltage E_{c1} without altering the voltage on the

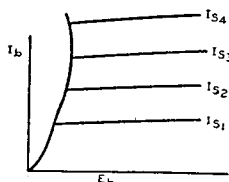

Fig. 17—Generalized "virtual-diode" characteristic.

positive grid G_2 , or on the plate. The virtual-diode spacing is increased with larger currents (due to the higher space charge) and is decreased with smaller currents with corresponding changes of the saturation potential E_m . This change in perveance of the virtual diode as a function of the real cathode current explains the possible *crossover of the plate characteristics* at low E_b values for different values of the control-grid voltage at fixed screen potential (Fig. 20) and for different values of screen voltage with fixed control-grid voltage.

(b) The General Virtual-Diode Characteristic in Tetrodes

Although space-charge limited, the current does not increase in the range below E_m with the three-halves power of the plate voltage as in diodes with a real cathode, but follows a more complicated relationship as shown by the curve in Fig. 17. The conductance of the characteristic increases at some point to infinity and then becomes negative. Depending on the electron reserve and spacing, the virtual diode may saturate at any current value of the generalized curve. The peculiar relation of current and voltage is produced by the fact that the virtual-diode spacing is not fixed as in diodes with real cathodes. These conditions are analyzed in Figs. 18(a), (b), and (c).

The space-potential depression E_v is a function of the electron density. The density varies not only with the total electron supply but also with the amount of electrons leaving the virtual cathode in both directions.

If the *plate voltage is zero or slightly negative*, a current towards the virtual cathode only is impossible, as it cannot disappear in space. Because the total current is zero, the same number of electrons must fly back from the virtual cathode to the screen as arrive at the virtual cathode from the screen. This brings about the condition that the virtual cathode cannot approach the positive grid beyond a certain minimum distance V_0 . The space potential between virtual cathode

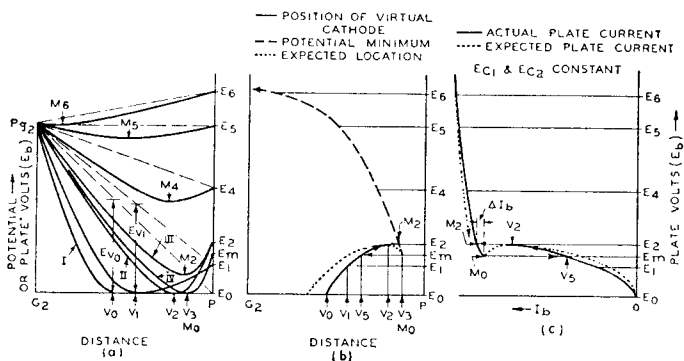

Fig. 18

- (a)—Potential distribution in a tetrode with high space-charge density between screen and plate.
- (b)—Location of virtual cathode and potential minimum in tetrode with high space-charge density.
- (c)—Plate characteristic of a tetrode with high space-charge density.

and positive grid is greatly affected by the magnitude of electron absorption at the positive grid wires, which is different for electrons of opposite direction due to beam formation by the grid wires.

A certain percentage of the electrons returning from the virtual cathode passes the screen grid and flies towards the cathode, comes to a stop, and flies again towards the screen. At negative and very low plate voltages, the number of returning primary electrons is very great. The electrons flying back towards the cathode reduce the space potential between screen and cathode and the effective potential near the cathode. Hence, the cathode current decreases. These circling electrons are responsible for the deviation of plate current and virtual-cathode position from the expected curves (dotted in Figs. 18(b) and 18(c)).

For the *positive plate voltage* E_1 , the virtual-cathode space charge

and potential depression in the grid-plate space is decreased by the plate current and the equivalent decrease in reverse current due to fewer returning electrons. Hence the virtual cathode moves toward a position satisfying the decreased potential depression E_{v1} , which is a position closer to the plate. As the virtual-diode spacing is decreased, the plate current increases simultaneously and causes a further decrease of distance until a stable position is reached, shown as V_1 in Figs. 18(a) and 18(b). If the electron reserve is not as large as shown, the virtual cathode will eventually saturate in such a stable position (I_{s1} and I_{s2} in Fig. 17). The case of a large saturation current is considered in the following, because it occurs with positive values of E_{c1} in the beam power tube (see Fig. 35).

The potential distribution (curve II in Fig. 18(a)) at $E_b = E_2$ is critical. V_2 has approached the plate sufficiently, so that the slightest increase in current starts a cumulative effect. V moves from position V_2 towards the plate, an action which increases the perveance and, hence, the plate current until saturation occurs somewhat before reaching the position V_3 (Figs. 18(a) and 18(b); E_2 is higher than E_m). Inasmuch as a stable minimum of zero value cannot be maintained by the plate voltage E_2 (only by the lower voltage E_m), the potential distribution changes to the stable curve III with a minimum M_2 of positive value. The jump of the minimum from zero to M_2 causes a plate-current increase ΔI_b (Fig. 18(c)), which is not the case under ideal conditions, but always true in practical tubes. Some electrons have lower velocities than others, due to differences in initial velocity at the real cathode, and especially due to tangential components obtained during their flight through the structure. These slower electrons are unable to pass a minimum of low absolute potential but gradually reach the plate as the plate voltage is increased. A further cause is the finite value of the amplification factor $\mu = -\partial e_p / \partial e_g$.

With further increased plate voltage, the minimum recedes from the plate (see Figs. 18(a) and 18(b)). It occurs near the center (exactly at the center in ideal parallel-plane tubes) for $E_5 = P_{c2}$ and then disappears for voltages higher than E_6 .

When the *plate voltage is decreased*, the plate current remains at saturation value and is stable until the minimum potential reaches zero value (M_0). This occurs with $E_b = E_m$, and is shown by curve IV in Fig. 18(a). A virtual cathode forms; the slightest decrease of plate current forces V to move away from the plate. This action becomes cumulative until the stable position V_5 (Fig. 18(b)) of high space-charge density is reached. The plate current drops suddenly to the value marked V_5 in Fig. 18(c).

(c) Optimum Plate Distance in Power Tetrodes

The control-grid voltage in power tetrodes varies the saturation current. It is best to saturate the virtual cathode at the value I_{s3} of Fig. 17 for zero control-grid voltage because the potential minimum M_0 is then stable and occurs close to the plate. The saturation potential E_m of the virtual diode in power tetrodes is the plate-voltage value at which the "knee" occurs. At plate voltages $E_b > E_m$ but $< E_{c2}$, a potential minimum of a least ten to fifteen volts less than plate potential must be formed between screen and plate in order to suppress secondary-emission effects. The virtual cathode is not a necessity for suppressor action but is formed eventually in all cases where a potential minimum is obtained at higher voltages.

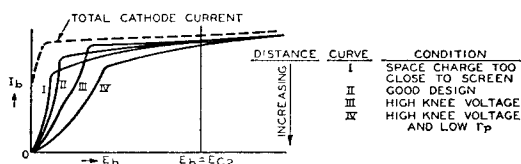

Fig. 19—Effects of plate-to-screen-distance variation on the plate characteristic in tetrodes having electrons with tangential components.

High plate currents at low plate potentials with respect to the screen potential require that the distance from virtual cathode to plate be short and uniform in order to obtain saturation at *one low plate-voltage value*. The plate distance can be made longer, if the area of the virtual cathode is increased which would indicate the use of a divergent electron path (wide beam angle) and circular structures. The potential *minimum after saturation should occur, however, closer to the plate* than to the screen and *should not be of large cross-sectional area*, to prevent a steep decelerating field. The latter undesirable condition is obtained either with very short plate distances and extreme electron densities or in circular structures with wide-angle electron beam and moderate electron densities. It causes high screen current and low plate impedance similar to high forward- μ suppressor grids located in pentodes too close to the screen grid. For these reasons circular structures with larger plate distances have been found unsatisfactory. The design of the structure for the saturation current I_{s3} in Fig. 17 results in a low saturation potential with high current due to the high diode conductance and causes the formation of a potential minimum sufficient for suppression of secondary-emission effects. The optimum distance ratio for the beam power tube (see page 156) is $\rho_{opt} = 2.9$. The beam angle is approximately 60 degrees. The curves I to IV in Fig. 19 illustrate the effects of plate-to-screen-distance varia-

tion in tubes having electrons with tangential components. The curves are understood from the aforesaid. Oscillogram checks for plate diameter changes in the beam power tube are shown in Fig. 20.

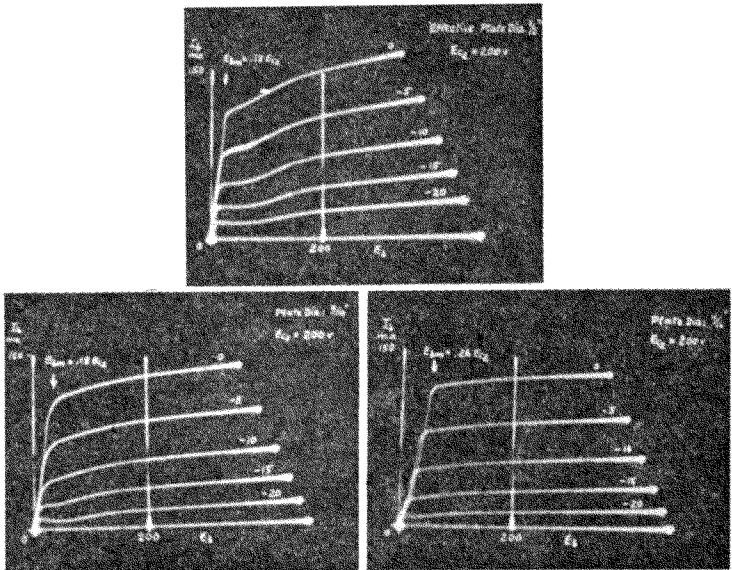

Fig. 20—Oscillograms showing plate characteristics for beam power tubes having different plate diameters.

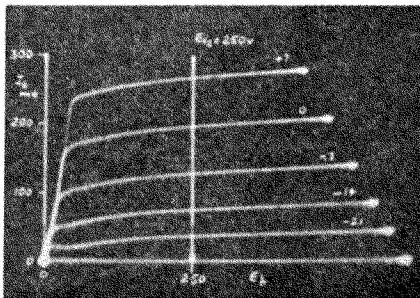

Fig. 21—Plate family of type 6L6 beam power tube.

B. Beam Formation and Structure of the Beam Power Tetrode

1. The Electron Beam in a Radial Plane

(a) The Beam between Accelerating Grid and Plate

It is essential to maintain electron direction and *density perfectly uniform* in any cross section of the electron path at any distance from

cathode or plate to approach the theoretical performance discussed in the preceding section. The electron current is thus formed into a beam with definite properties.

The beam density at saturation current for the condition I_{s3} in Fig. 17 was found to be 28 milliamperes per square centimeter at the plate for $E_{c2}=250$ volts and $E_{c1}=0$ volts. The restriction of the electron beam to a section of a cylindrical structure with large radius is necessary to obtain high plate impedance and low screen current.

A series of tests has shown that the desirable relatively short plate distance will invariably cause a serious loss of plate current, a badly rounded "knee," or give rise to secondary-emission effects, unless the *utmost care is taken* in the design of the entire electrode structure to produce and maintain at low plate voltages a uniform electron beam that neither spreads nor compresses and has the required density and

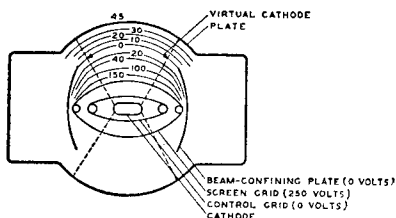

Fig. 22—Cross section and potential plot of beam power tube.

cross section when decelerated. The horizontal-beam cross section and location of the virtual cathode at saturation voltage in the beam power tube are indicated in the sectional view of the beam power-tube structure in Fig. 22.

In the screen-plate space, the electron beam in a radial plane is confined to a sector by two "beam-confining" plates at cathode potential. Virtual cathode and potential minimum stop secondary electrons from the plate. The beam-confining plates continue this potential barrier outside of the electron stream and prevent the return of secondary electrons along the sides of the beam. Ideal beam-confining plates should terminate all potential lines abruptly without distorting their uniformity. Shape and spacing of the actual plates is thus adjusted for best termination of the potential lines on the beam borders at low plate-voltage conditions. The edges of the plates point to the zero-potential plane of the virtual cathode at saturation potential. A mechanical analogy for explaining the shape of the radial field would be a tapered chute with bent-up sides and a curved bottom. The model in Fig. 25(b) shows the smooth bottom of this "chute."

(b) The Beam between Cathode and Screen Grid

Having provided a suitable radial path for the electrons beyond the screen, we must further supply an electron stream of uniform density and velocity to the plane of the screen. Starting at the cathode, we must maintain the electron-beam density at any distance from the cathode substantially constant over the sector width by adjusting the *radius of curvature of the grids*. The sectional view in Fig. 22 shows that the radius of curvature of the electrodes is *decreasing* with distance. This is because a radius correction is necessary to compensate for

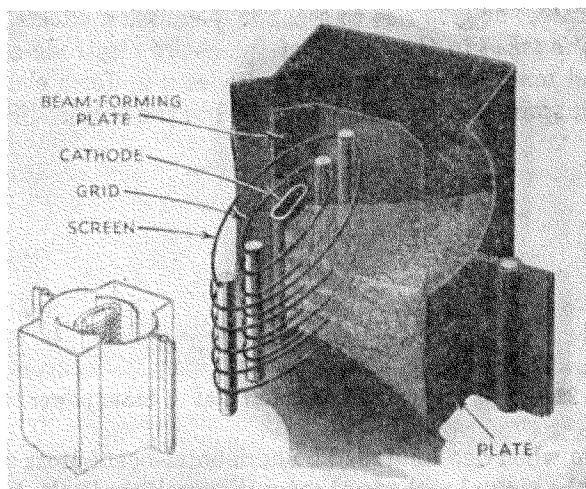

Fig. 23—Beam formation in type 6L6 beam power tube.

side-rod effects. The *flattened cathode* gives a more uniform and larger effective area than a round cathode with consequent gain in transconductance and power sensitivity. Spacing and cross section of the *grid side rods*, especially of the control grid, determine the beam angle and thus are fixed for a given current density in the decelerating field. With negative control-grid voltages, the beam angle is reduced by the control-grid side-rod field and thus some secondary electrons from the plate travel to the screen grid along the edges of the beam. This can be prevented but is unnecessary in a power tube.

2. The Beam Formation in a Longitudinal Plane

(a) Subdivision of Cathode Current by Grid Wires into Directed Beams of Disk-Sector Shape

If the resultant field in the control-grid plane is positive, electrons leave the space-charge cloud at the cathode and travel with increasing

velocity in a path which approaches the position of a flux line. In tubes with negative control-grid voltage, the entire electron stream is divided into definite beams. In conventional tubes, no attempt is made to direct these beams, with the result that the electron streams have varying density and direction (see Fig. 12). These undirected beams of emission are responsible for a considerable absorption of electrons at the screen and a large variation of electron direction in the decelerating field beyond the screen, which causes gradual saturation no matter how uniform the electrostatic field is made in the space between screen and plate.

The misalignment of grid wires (see Fig. 12) in conventional pentodes permits electrons to pass at any point between the screen wires; the potential in the plane of G_2 varies more than 50 volts. In the case shown, four beams are formed within one period of grid-wire alignment. The main beam area is shaded. Two of the main beams pass between the wires of G_2 and only stray electrons are intercepted directly. The other two beams, however, hit the wires of G_2 which intercept approximately 25 per cent of the beam current. The screen current intercepted directly is thus approximately 12.5 per cent of the cathode current. This value is obtained only at high plate voltages where all electrons passing the screen are collected by the plate. At lower plate voltages, electrons with tangential components fall back into the screen grid. For the particular tube and voltage shown, they amount to 20 per cent of the cathode current. Thus, the screen collects approximately one third of the total cathode current for the condition shown. To prevent serious overheating of the bombarded screen wires, the grids are wound with opposite thread so that the bombarded length of wire per turn is reduced and so that the total bombarded length is distributed over more turns.

Directed electron beams are formed when the entire length of all screen wires in the electron current is positioned in the electrical shadow of the control-grid wires. Certain distance relations are necessary to maintain a narrow beam width between the wires of G_2 within the range of the variable control-grid voltage of power tubes in order to minimize screen current, and prevent serious divergence of electron paths at low plate voltages in the decelerating field beyond the screen.

The control-grid voltage governs the focal length of the beams, and thus their divergence for given electrode and grid-wire distances. Simultaneous adjustments must be made when designing the tube structure because control-grid voltage, plate current, and beam focus depend on the same physical space relations between grid wires, grids, and cathode.

(b) Advantages of Directed Beam Formation

i. Substantially uniform current density and electron direction at the virtual cathode in a direction parallel to the cathode axis is obtained. (The beams meet. See Fig. 24.)

ii. The low screen dissipation increases the efficiency of the tube.

iii. The low screen current gives an unusual flexibility of operating conditions, as the screen voltage can be stabilized with bleeders of low power dissipation.

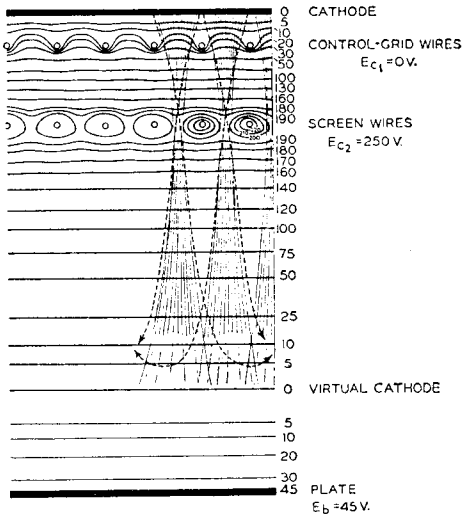

Fig. 24—Potential field of type 6L6 beam power tube for the condition of virtual-cathode saturation.

iv. Higher screen-voltage ratings are permitted with consequent increase in power output.

v. The power sensitivity can be increased without danger of grid emission, because the screen temperature is low.

vi. The field distribution parallel to the axis of the cathode is more uniform at the cathode than in tubes with grids of different pitch and periodic misalignment of grid wires. This uniformity permits obtaining higher transconductance values with good plate-current cutoff.

(c) The Beam Formation in the Beam Power Tube

Developmental power tubes have been constructed with individual beams of long focal length formed by negative grid wires and sharply focused between the positive screen wires. The screen-grid current at the operating point was reduced to less than two per cent of the plate-

current value. The spacing requirement is, however, not suitable for high power sensitivity.

The distance between control grid and cathode is determined by the power sensitivity, and the control-grid pitch and wire size by the cutoff characteristic, as explained later. *The formation of directed beams requires equal pitch of control and screen grid.* Hence, for a given set of the above conditions, the distance ratio of d_{G1-G2} to the pitch distance is the main variable. It determines the focal length of the beams and also plate-current, screen-current, and control-grid voltage. In order to satisfy also the requirements for grid side-rod spacing, radius of curvature, power-dissipation capability of the plate, and low grid emission, a balance of the various tube properties is necessary to result in a generally desirable structure.

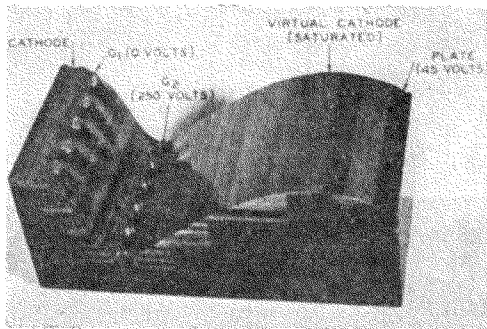

Fig. 25—Topographic model of potential field shown in Fig. 24.

An artist's sketch of the total beam formation in the beam power tube at a low plate voltage is shown in Fig. 23. The control-grid beams have the form of sheets. The dense area near the plate indicates the location of the virtual cathode also shown in Fig. 22. The cathode current is split up into two groups of 43 narrow beams. The ratio of the grid distance (d_{G1-G2}) to the grid-wire spacing is 1.4.

The potential field of the beam power tube and a topographic model are shown in Figs. 24 and 25. The uniformity of the field between screen grid and plate is apparent. The plate voltage shown is the saturating potential (45 volts) of the virtual cathode (knee), and thus the hill in front of the plate has an elevation just equal to that of the cathode. The control-grid mountain peaks (shown for zero grid voltage) direct the electron "balls" towards the narrow ridge between the screen-grid holes. Less than nine per cent of the electrons at the sides of the beams is deflected from a linear path by the conical holes, loses radial velocity,

and turns back from the virtual-cathode hill to the screen. About three per cent of stray electrons is intercepted directly. All others have just sufficient momentum to roll over the virtual-cathode hill to the plate. With increased plate voltage ($E_b > 45$ volts), the elevation of the plate decreases (in the model) as does also that of the potential minimum in front of the plate. The electrons including those with tangential components pass easily over the lower hill in front of the plate but hit the plate with considerably more impact. The hill in front of the plate, however, prevents them from bounding back and rolling back to the screen valley. In an actual tube, however, the primary electrons stay bound at the plate, but secondary electrons are knocked off and are the ones which are prevented from reaching the screen valley.

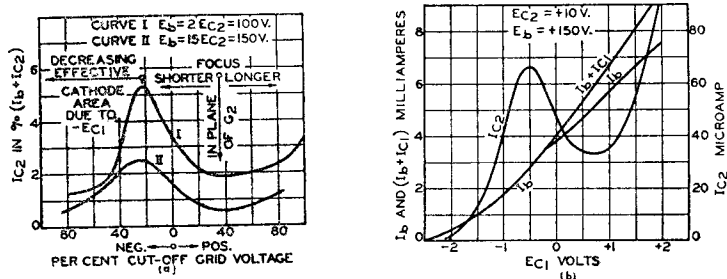

Fig. 26

- (a)—Changes of beam focus and current intercepted by the screen as a function of control-grid voltage in a beam power tube.
 (b)—Current distribution in a beam power tube as a function of control-grid voltage.

The beams come to a focus in the plane of the screen grid with a positive control-grid voltage, and cause a screen-current minimum (see Figs. 26(a) and 26(b)). The focal length is decreased with increased negative control voltages. Consequently, the beam width in the plane of G_2 is increased. The increase of I_{c2} is, however, checked by the decrease in effective cathode area opposite the grid-wire space due to cutoff conditions. This narrows the convergent angle so that the divergence and beam width beyond the focus actually reduce for high bias values with consequent low current absorption. A low screen voltage and high plate voltage were used in obtaining the curves of Figs. 26(a) and 26(b) to minimize secondary-emission effects from the screen.⁸

⁸ I am indebted to Mr. H. C. Thompson, who has studied beam principles for many years in our laboratory, for his explanation of beam theory. His paper, "Electron beams and their applications in low voltage devices," appeared in the Proc. I.R.E., vol. 24, pp. 1276-1297; October, (1936).

The transfer characteristic of the tube follows the square law in order to reduce third-harmonic distortion. The control-grid-wire distance from the cathode was made shorter than the grid-wire spacing (ratio 2 to 3) so as to cause the effective area of the control potential to vary substantially with the one-half power of the applied control-grid voltage as pointed out in the discussion of the pentode plate char-

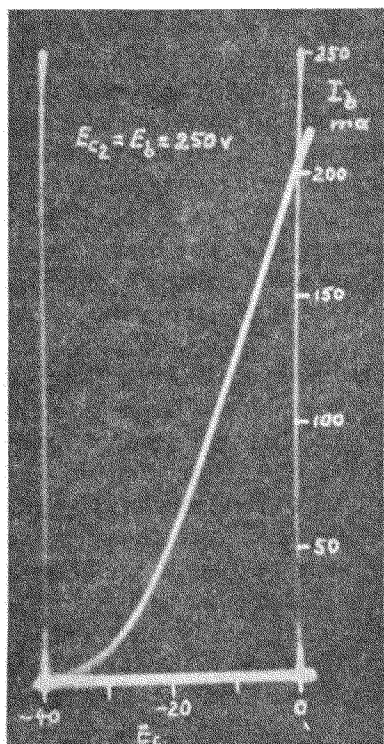

Fig. 27—Transfer characteristic of type 6L6 beam power tube.

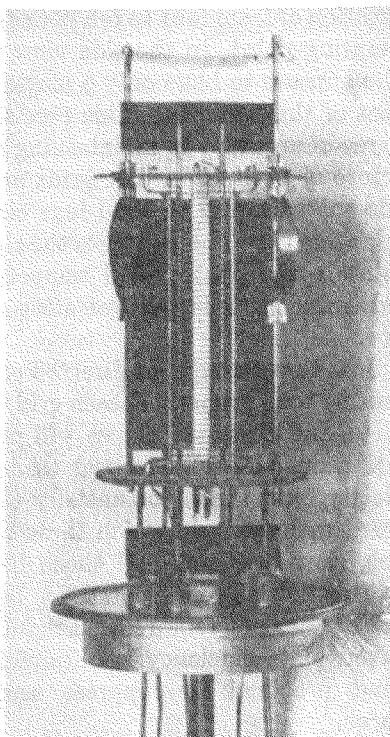

Fig. 28—Type 6L6 with cutaway plate to show grid-wire alignment.

acteristic. The desired result is obtained because the positive potential source (the screen) remains at a fixed potential and because side-rod effects are compensated for by electrode shape adjustment. An oscillogram of the transfer characteristic is shown in Fig. 27.

The *plate characteristics* of the beam power tube are shown in the oscillogram in Fig. 21. Insufficient minimum potentials are indicated at highly negative grid voltages by the presence of secondary-emission effects but they have no harmful consequences inasmuch as this section of the plate characteristics is not utilized in practical operating

conditions. Although the beam power tube was designed for operation with screen voltages between 250 and 300 volts, it may be operated within a wide screen-voltage range without substantial performance loss.

The beam power tube is the first tube in large quantity production to utilize grids in register. The alignment is held at present within 0.004 inch for all grid wires. This corresponds to a screen-current variation of from four to ten per cent of the plate current at the normal operating point. In the side view with cutaway plate in Fig. 28, the tube appears to have only a single grid on account of the exact alignment of the two grids. This precision is obtained by means of a high degree of accuracy in maintaining a constant pitch angle in the manufacture of both grids. The grids are aligned mechanically and all side rods are anchored to weld lugs clamped in a "terminal board" mica which positions and supports the electrodes rigidly. Two heat radiators maintain the control-grid temperature at a low value to minimize grid emission under all operating conditions within the rating of the tube.

It is thus found that directed electron beams obtained by electrical focusing with properly chosen grid wires, grid side rods, beam-confining plates, and electrode shapes will produce an electron stream of nearly ideal properties with respect to uniformity of electron direction and velocity, and that substantially theoretical performance may be obtained with tubes in which these beams are used. In the beam power tube, slow electrons and those having large tangential components are substantially prevented by beam formation; hence, large plate spacings are not required, wasteful screen current is avoided, and improved plate efficiency is obtained. In this beam power tube it was found practical to suppress secondary-emission effects by space charge.

Tubes which do not utilize carefully directed electron beams, but use the space-charge type of secondary-emission suppression, require long distances between screen grid and plate for satisfactory results and have been found to show little improvement over existing commercial pentodes. Such tubes with a large screen-to-anode distance, may be made to have a characteristic with a fairly defined knee occurring at somewhat higher voltages than in a beam tube, but the magnitude of the screen current at lower plate voltages prevents highly efficient tube operation. Tubes of this type with long distance between screen grid and anode have been discussed by J. H. O. Harries⁹ of London, England, in recent articles.

⁹ "Critical distance tubes," *Electronics*, vol. 9, p. 33; May, (1936).

VI. THE PERFORMANCE OF THE BEAM POWER TUBE

A. Single-Tube Operation

1. Distortion, Efficiency, and Ratings

The harmonic distortion of a single tube is of substantially second-harmonic order, and decreases linearly with signal according to theory. Higher orders than the third are negligible (see Figs. 29(a) and 29(b)). The percentage of second harmonic is comparatively large if the grid

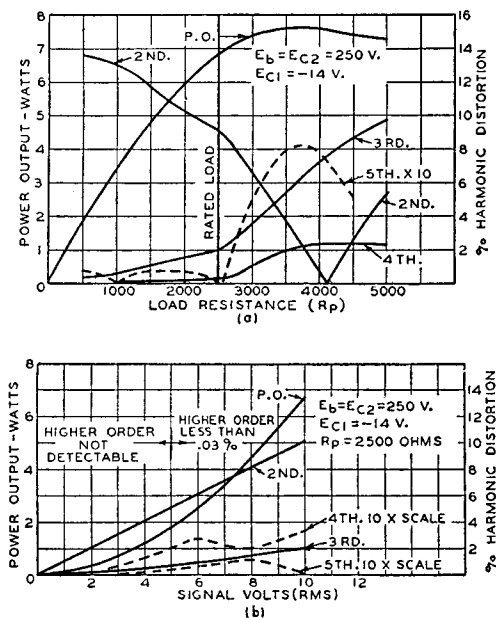

Fig. 29

- (a)—Harmonic distortion and power output as a function of load resistance for type 6L6 at peak input signal volts equal to the grid-bias voltage.
 (b)—Harmonic distortion and power output as a function of input signal voltage for type 6L6 with 2500-ohm load.

bias is selected for high efficiency as shown in Fig. 30(a) by the values calculated from the ideal characteristic of parallel straight lines with square-law spacing. A comparison of actual tube performance (Fig. 30(b)) with these values shows better efficiency at the same values of second-harmonic distortion because a small value of third-harmonic distortion has been intentionally allowed by designing the plate characteristic as shown by curve II in Fig. 19.

Various measurements have proved that it is always possible to reduce the total distortion to six per cent or less with resistance-coupled

preamplifiers (triodes or pentodes) by generating in these amplifiers operated with reduced plate loads a canceling second harmonic of sufficient magnitude. A third harmonic produced in preamplifiers is usually additive to the third harmonic in the output stage except in special operation of push-pull preamplifiers.

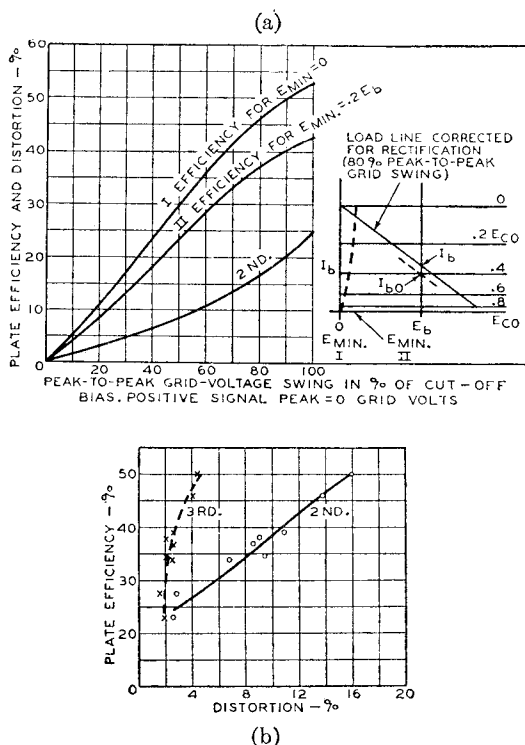

Fig. 30

- (a)—Performance of hypothetical screen-grid tube with linear characteristics and square-law transfer characteristic.
 (b)—Performance of beam power tube for various operating conditions at maximum signal input without grid current.

The flexibility of screen-voltage values permitted by the low screen current results in large power-output ratings as well as high power sensitivity as tabulated in Table I.

In contrast to standard practice for pentodes, the plate load is not selected for minimum total distortion (Fig. 29(a)), but for a minimum of higher-order distortion in accordance with the previous discussions, because the design of the tube allows nearly maximum power output to be obtained with such loads.

TABLE I

Static and Dynamic Characteristics	
Heater voltage.....	6.3 volts
Plate voltage.....	250 volts
Screen voltage.....	250 volts
Grid voltage.....	-14 volts
Amplification factor.....	135
Plate resistance.....	22500 ohms
Transconductance.....	6000 micromhos
Plate current.....	72 milliamperes
Screen current.....	5 milliamperes

Single-Tube Class A1 Amplifier*

Plate voltage.....	375 max. volts
Screen voltage.....	250 max. volts
Plate and screen dissipation (total).....	24 max. watts
Screen dissipation.....	3.5 max. watts
Typical operation:	

	6.3		6.3		6.3		6.3 volts
	375		250		300		375 volts
	125		250		200		250 volts
	<i>Fixed Bias</i>	<i>Self-Bias</i>	<i>Fixed Bias</i>	<i>Self-Bias</i>	<i>Fixed Bias</i>	<i>Self-Bias</i>	<i>Fixed Bias</i>
Heater voltage.....							
Plate voltage.....							
Screen voltage.....							
Direct grid voltage.....	-9	—	-14	—	-12.5	—	-17.5 volts
Self-biasing resistor.....	—	365	—	170	—	220	ohms
Peak audio-frequency grid voltage.....	8	8.5	14	14	12.5	12.5	17.5 volts
Zero-signal direct plate current.....	24	24	72	75	48	51	57 milliamperes
Max.-signal direct plate current.....	26	24.3	79	78	55	54.5	67 milliamperes
Zero-signal direct screen current.....	0.7	0.7	5	5.4	2.5	3	2.5 milliamperes
Max.-signal direct screen current.....	2	1.8	7.3	7.2	4.7	4.6	6 milliamperes
Load resistance.....	14000		2500		4500		4000 ohms
Distortion:							
Total harmonic.....	9		10		11		14.5 per cent
2nd harmonic.....	8		9.7		10.7		11.5 per cent
3rd harmonic.....	4		2.5		2.5		4.2 per cent
Max.-signal power output.....	4.2	4	6.5	6.5	6.5	6.5	11.5 watts
Plate and screen efficiency (total).....	42	43	30		37.2		43 per cent

* Suffix 1 indicates that grid current does not flow during any part of the input cycle.

2. Overload Characteristics

In all ideal audio-frequency amplifier tubes, whether triodes or pentodes, the efficiency has reached the maximum value of 50 per cent with normal operating conditions and zero peak grid volts. A so-called "smooth overload" characteristic as obtained in tubes having low efficiency at the rated output value is thus not obtainable in class A operation for audio-frequency purposes. An analysis of the ideal triode characteristic shown in Fig. 2 shows that distortion at the grid-current point is very small and rises steeply for further increases in signal voltages because the plate voltage at the current maximum can only increase 50 volts at most. This fact is not altered by the assumption of a control grid which draws no current even with high positive grid voltages.

The plate-current knees in the beam power tube occur at a low plate voltage. A high plate load intersects a knee of a negative-control-grid-voltage line. The corresponding peak swings of voltage and current do

not increase any further with larger grid signals, although these may be negative. Power output and efficiency are increased but at the expense of higher distortion because plate-efficiency values over 50 per cent require that the wave approach a "flat-topped" or square form.

B. Push-Pull Operation

1. General Discussion of Push-Pull Amplifiers Having High Power Sensitivity.

Push-pull amplifiers are used in radio receivers not only for balancing out various current components in transformers and load, but also to obtain low distortion and increased efficiency of tube and circuit operation. It is highly important to analyze the performance of hypothetical tubes with high power sensitivity in amplifier circuits having commercially obtainable power supply regulation.

(a) Triodes

The dynamic characteristic of triodes having a constant μ and a plate impedance much lower than the plate load (as, for instance, the ideal tube shown in Fig. 2) is substantially linear. The resultant characteristic of two tubes in a push-pull circuit is thus represented by the geometric addition of two straight lines. Fig. 31 shows the joined characteristics for five distinct operating points. Dotted lines mark the grid-current point. Conditions 1 and 2 show class A1 operation; condition 2 is for class A1 operation with minimum plate current. Both conditions give zero distortion. The power output and efficiency of condition 1 is naturally less than for condition 2 which is limited to 50 per cent efficiency. Class AB1 operation, as shown in condition 3, has still higher efficiency because I_{b0} is lower than $\frac{1}{2} I_{max}$. The breaks in the curve, however, cause distortion including high orders. Condition 4 shows the very critical class B1 operation having zero distortion and a maximum theoretical efficiency for ideal audio amplifiers of 78.6 per cent.

In practical amplifiers the supply voltages vary with current increments because of imperfect regulation. The operation of ideal triode amplifiers is thus limited to class A conditions. A pair of hypothetical triodes (Fig. 2) operated as push-pull class A1 amplifiers at maximum efficiency as in Fig. 31, condition 2, requires a direct grid voltage (E_c) of -37.5 volts and a plate voltage (E_b) of 400 volts for 35 watts output with 51 per cent plate efficiency and negligible distortion. The characteristic (Fig. 2) of these hypothetical tubes was constructed to obtain a performance approximately equal to the beam power tube. Because of the high triode conductance, the plate-current increment due to signal is sufficient to shift the operating point to zero plate

current (Fig. 31, condition 4), if the plate-voltage regulation is 6.25 per cent.

It can be shown that self-biased operation of these tubes requires a minimum plate current of 85 milliamperes per tube in order to prevent complete cutoff (condition 5) at full signal. The rectification in actual tubes would be larger and the obtainable efficiency would be reduced

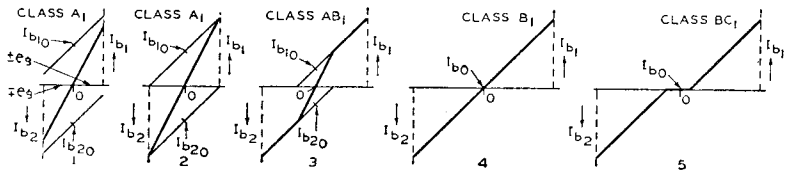

Fig. 31—Push-pull characteristics for triodes having linear dynamic characteristics.

to the order of 35 per cent because the required operating condition would necessitate a higher plate current and cause higher plate dissipation.

(b) Pentodes and Beam Power Tubes

For equal power sensitivity the stability of the operating point is considerably better in tubes with accelerating grid. The screen prevents the control of the plate voltage over the plate current and thus the required transconductance for equally good efficiency and power sensitivity is considerably lower than in triodes.

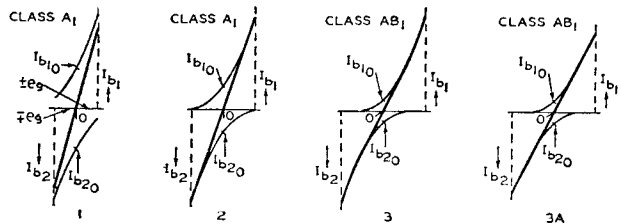

Fig. 32—Push-pull characteristics for ideal pentodes having square-law dynamic characteristics (sketches 1, 2, and 3); push-pull characteristic of beam power tube (sketch 3A).

The dynamic transconductance obtained with two of the new beam power tubes in push-pull is 4000 micromhos per tube while that of the equivalent hypothetical triode would have to be 56,000 micromhos.¹⁰

¹⁰ It can be shown that for a triode power tube to equal the performance of a pentode power tube the following ratio holds:

$$\frac{g_m \text{ (triode)}}{g_m \text{ (pentode)}} = \frac{2(E_{b0} - E_{bm})}{E_{bm}}$$

For $E_{b0} = 400$ volts and $E_{bm} = 50$ volts, we obtain $g_m \text{ (triode)} = 14 g_m \text{ (pentode)}$.

The curvature of a high-impedance plate characteristic is *not* straightened out by the plate load. This permits operation with smaller quiescent plate currents and thus higher efficiency, as illustrated in Fig. 32. The resultant characteristic from two square-law curves is linear for the class A1 operating conditions 1 and 2. The overbiased operation in condition 3 does not cause high-order distortion because the curve does not have sharp breaks.

In the design of the beam power tube the plate characteristics in the low plate-voltage range are so adjusted that the distortion minimum (0.8 per cent) is obtained in push-pull class AB1 operation with a quiescent plate current of 28 milliamperes per tube, i.e., $I_{b0} = 0.14 I_{max}$ at $E_{c1} = 0.625 {}_{c0}E_c$. The high-current end of each individual dynamic characteristic is straightened out by the plate load so that only the square-law sections of the individual characteristics have to be overlapped (3A in Fig. 32). Class A1 operation of these tubes causes an increase in distortion to two per cent which, due to the absence of higher orders, is not objectionable. Plate-current increments above the knee are substantially proportional to the one-half power of the plate voltage over the range in which a potential depression is caused by space charge between G_2 and the plate.

2. Performance of Beam Power Tubes in Conventional Push-Pull Service

The new all-metal beam power tube is designed for class A1 and class AB1 operation.¹¹ Two self-biased tubes in push-pull class AB1 are capable of delivering without grid current a power of 32 watts with 58 per cent plate-plus-screen-power efficiency, and 54 per cent direct-current-power efficiency including self-biasing power. Including heater power, the total circuit efficiency is 45 per cent. Distortion has the small value of one to two per cent and is of substantially third-harmonic order. Other harmonics are small fractions of one per cent, no larger or of higher order than found in the output of push-pull low-impedance triodes.

With only 350 milliwatts peak grid power, a power output of 60 watts with two per cent plate distortion and with efficiency similar to that just given is obtained in class AB2 operation for use in large sound systems. Operation with grid current is not recommended for high quality reproduction due to the generation of higher harmonics in the grid circuit. The small grid power permits a driver design of low distortion.

The cathode is of the indirectly heated type operating with 6.3 volts alternating or direct current and 0.9 ampere, i.e., 5.7 watts.

¹¹ The tube has been made available under the type number 6L6.

Correct self-bias operation is highly efficient and does not require good supply-voltage regulation, as may be seen from the table comparing fixed-bias and self-bias operation in Table II. The self-bias

TABLE II

Push-Pull Class AB1 Amplifier				
Plate voltage.....	400 max. volts			
Screen voltage.....	300 max. volts			
Plate and screen dissipation (total).....	24 max. watts			
Screen dissipation.....	3.5 max. watts			
Typical operation—2 tubes:				
<i>Values are for 2 tubes</i>				
Heater voltage.....	6.3	6.3	6.3	6.3 volts
Plate voltage.....	400	400	400	400 volts
Screen voltage.....	250	250	300	300 volts
	<i>Fixed Bias*</i>	<i>Fixed Bias</i>	<i>Self-Bias</i>	<i>Fixed Bias*</i>
Direct grid voltage.....	-20	-20	-25	-25 volts
Self-biasing resistor.....	—	190	200	— ohms
Peak audio-frequency grid-to-grid voltage.....	40	40	43.8	50 volts
Zero-signal direct plate current.....	88	88	96	102 milliamperes
Max.-signal direct plate current.....	126	124	110	152 milliamperes
Zero-signal direct screen current.....	4	4	4.6	6 milliamperes
Max.-signal direct screen current.....	9	12	10.8	12 milliamperes
Load resistance (plate to plate).....	6000	8500	6600	3800 ohms
Distortion:				
Total harmonic.....	1	2	2	0.6 per cent
3rd harmonic.....	1	2	2	0.6 per cent
Max.-signal power output.....	20	26.5	24	23 watts
Plate and screen efficiency (total).....	38	50.5	52	51.5 32 58 35 per cent

* Plate load decreased to permit operation with grid current.

resistor is selected such that the plate and the screen rectification at full signal do not shift the bias beyond the value of minimum distortion and highest efficiency. Because of the high power sensitivity, the voltage changes are small causing but a slight decrease in power output. The amplitude distortion of -0.8 decibel in input voltage due to the self-bias shift is not detectable by the ear.

The advantages offered by push-pull amplifiers utilizing tubes with accelerating screen grids are augmented by the use of beam power tubes. Owing to their characteristics and their precision of manufacture, it is possible to obtain substantially the same performance in the practical use of beam power tubes as is obtained under ideal conditions. No matching of beam power tubes is required.

C. Circuits with Inverse-Voltage Feedback for Adjustment of Tube Impedance

1. Theory

Low plate impedance has been shown to be inconsistent with regard to design and operation of practical highly efficient power tubes. As low plate impedance is, however, one of the specified properties of an ideal power tube, circuit means for changing the effective plate impedance of tubes were investigated.

The plate impedance of a vacuum tube is defined as $r_p = d_{e_p}/d_{i_p}$ and measured by the ratio $\Delta e_p/\Delta i_p$. If the increment Δe_p , or a percentage of Δe_p in the plate circuit is coupled back into the grid circuit, it will increase or decrease the plate-current change Δi_p depending on the phase of the feedback. If, furthermore, the phase of the feed-back voltage is in opposition, i.e., "inverse," to the grid-voltage change which causes the plate-voltage change Δe_p , stable operation is obtained; the circuit is not regenerative.

The circuit in Fig. 33(a) has 100 per cent inverse-voltage feedback. If a voltage increment $+\Delta e_p$ is produced in the circuit branch normally containing the load resistance, the plate-current increment without

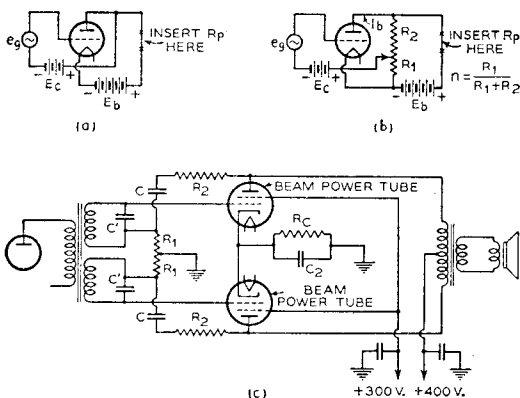

Fig. 33

- (a)—Circuit for 100 per cent conductive feedback ($n=1$).
 (b)—Circuit with adjustable conductive inverse feedback ($n < 1$).
 (c)—Practical inverse-feed-back circuit utilizing push-pull beam power tubes.

$R_1 = 10,000$ } or 5000 } for 10 per cent feedback
 $R_2 = 90,000$ } $45,000$ }

R_C = self-bias resistor

$C = 0.1$ microfarad or larger

C' = value depends on secondary impedance of transformer and should be determined by test. Large values require a series resistor to prevent transients.

$C = 35$ -volt electrolytic condenser (50 microfarads).

feedback is $+\Delta i_{p1} = +\Delta e_p/r_p$. Due to the feed-back connection, however, the grid voltage is changed simultaneously by the increment $+\Delta e_g = +\Delta e_p$. This causes a further plate-current change $+\Delta i_{p2} = \Delta e_g \times g_m$, and thus

$$\Delta i_p = \Delta i_{p1} + \Delta i_{p2} = \Delta e_p (1/r_p + g_m).$$

The resultant value of plate resistance is thus

$$r_{p(r)} = \frac{1}{1/r_p + g_m} = \frac{r_p \times 1/g_m}{1/g_m + r_p} = r_p \parallel 1/g_m.$$

The feedback causes an effective shunt $r_p' = 1/g_m$ across the actual plate impedance. The new resultant value $r_{p(r)}$ in this circuit requires a change in magnitude of amplification factor in order to satisfy the tube equation $\mu = g_m \times r_p$. Because the plate and grid circuit do not contain any common resistances, g_m remains constant and thus the resultant amplification factor (μ_r) is

$$\mu_{(r)} = g_m \times r_{p(r)}$$

which can be written

$$\mu_{(r)} = \mu / (1 + \mu).$$

The feedback n in this circuit is unity. Less feedback ($n < 1$) results in smaller changes of r_p and μ , because in general

$$r_{p(r)} = r_p \parallel \frac{1}{n \times g_m}$$

where n = feed-back factor, and

$$\mu_{(r)} = \frac{\mu}{1 + n\mu}.$$

The distortion in circuits with 100 per cent inverse feedback has been investigated by F. H. Shepard, Jr., of the RCA Radiotron Division. He found it to be extremely low, because it is reduced approximately by the same factor by which the required grid signal must be increased. Circuits with unity feedback ($n = 1$) require a grid signal equal to the sum of plate and grid-signal voltage and thus have very low power sensitivity.

A modification of the circuit for obtaining fractional feed-back values ($n < 1$) is shown in Fig. 33(b), in which the feed-back value $n = r_1(r_1 + r_2)$ may be adjusted at will. The circuit shown has a conductive feed-back connection, which permits the plotting of the resultant plate characteristic of the tube with feedback by any conventional method.

Oscillograms of feed-back characteristics of the beam power tube taken with a cathode-ray curve tracer for 10, 20, and 30 per cent inverse feedback are shown in Fig. 34. Because the oscillograms require a flat frequency characteristic with zero phase distortion from 10 to approximately 10,000 cycles, they prove the frequency stability of the circuit. The decrease of $r_{p(r)}$ and $\mu_{(r)}$ with increased feedback is obvious.

2. Graphic Construction of Feed-Back Characteristic

The construction of the characteristic with feedback from the original characteristic is not difficult. As illustrated in Fig. 35, it is obtained by simply adding $-n E_b$ to all grid-voltage values and draw-

ing curves through all points $-(E_{c1} + nE_b) = -E_{01(r)}$ of equal voltage.

The construction furnishes the correct resultant values of $\mu_{(r)}$ and $r_{p(r)}$ (g_m is unchanged) at any point of the feed-back characteristic. The original

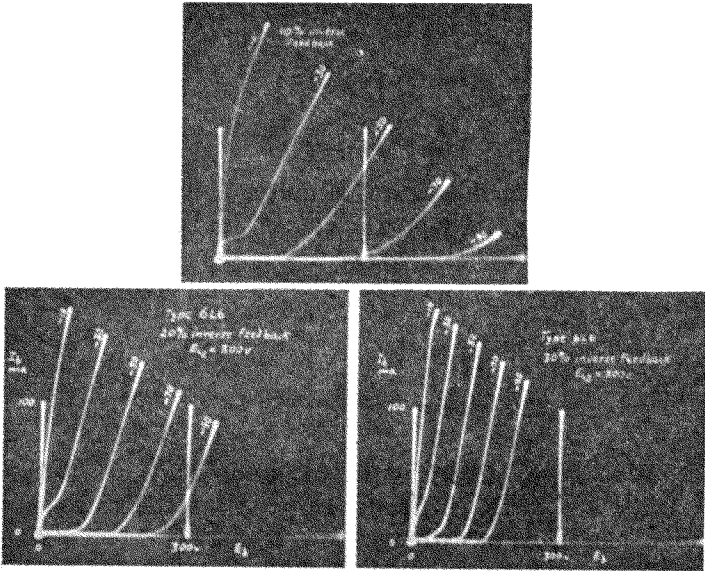

Fig. 34—Oscillograms showing effects of inverse feedback on plate characteristics of a beam power tube. Oscillograms taken with the curve tracer using circuit of Fig. 33(b).

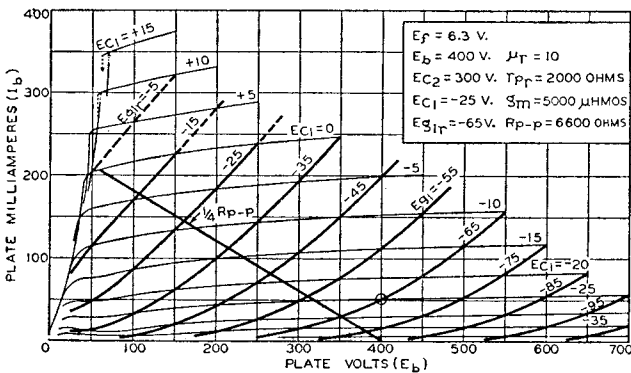

Fig. 35—Inverse feedback plate characteristics for $n=0.1$ constructed from the static plate family of the 6L6 beam power tube.

zero-bias line is the envelope of all values without grid current. It is further seen that the position of the optimum plate load and the power output, as determined for all normal operating conditions, remains

unchanged. Distortion analysis, however, will show a reduction of distortion in approximate proportion to the required signal increase.

3. Performance of Beam Power Tubes in Practical Circuits with Inverse-Voltage Feedback

Conductive feedback is unnecessary in audio-frequency amplifiers. The correct phase relation is least disturbed by a resistance-capacitance coupling as shown in the practical circuit of Fig. 33(c). The blocking condensers C eliminate direct-current feedback and thus make it unnecessary to change the original grid-biasing voltage. *This measure avoids* at the same time possible *plate-current cutoff due to rectification*, because the direct-current plate conductance is not increased to the high value of a real triode.

The high power sensitivity of the beam power tube requires the value of only 10 per cent feedback to effect a *loud-speaker damping equal to that obtained with class A1-operated low-impedance triodes*. The required grid signal as obtained from the push-pull operating condition illustrated in the feed-back characteristics of Fig. 35 is 60 peak volts at the grid-current point. The operating bias (E_{g1}) is -65 volts which would be the direct-current bias value for the conductive feed-back connection. Since the practical feed-back connection contains a blocking condenser, the direct-current bias on the tube is -25 volts. The power output remains 32 watts, a small percentage of which is dissipated in the potential divider. The distortion is reduced to approximately 0.6 per cent. The high circuit efficiency is substantially unaltered.

A possible phase reversal due to leakage-reactance tuning of the input transformer is prevented by connecting small condensers across each secondary winding. Plate-load compensation is unnecessary due to the low effective plate impedance of the tubes. The low $r_{p(r)}$ of the tubes will give less trouble from hum than triodes, due to better stability of the operating point, but naturally requires a better filtered B supply voltage as compared to pentode operation.

Circuits with un-by-passed cathode resistor are also inverse-feed-back circuits. In single-tube operation such circuits will reduce the distortion of the beam power tube to approximately one half of its normal value while the required grid signal will be doubled and the output power reduced approximately 10 per cent by the loss in the cathode resistor. It can be shown that this feed-back method *increases the effective plate impedance* of the tube *with respect to a separate plate-circuit load* and *decreases the tube impedance with respect to the cathode resistor*. For damping purposes, therefore, this method is efficient only for 100 per cent inverse feedback, i.e., if R_p is located in the cathode lead.

CONCLUSION

By the use of new principles in design and application of power tubes, we have in the beam power tube closely approached ideal power-tube characteristics and performance. The development of this tube has been made possible by the splendid co-operation and specific knowledge of many fellow engineers, to whom I want to express my sincere appreciation.