

MN3007

1024-STAGE LOW NOISE BBD

General description

The MN3007 is a 1024-stage long delay low noise BBD that provides a signal delay of up to 51.2msec.

The MN3007 is particularly suitable for use as reverberation effect of electronic musical instrument such as stereo equipment due to its long delay times.

Features

- Variable delay time of audio signal: 5.12 ~ 51.2ms.
- Clock component cancellation capability.
- No insertion loss: $L_i = 0\text{dB}$ typ.
- Wide dynamic range: $S/N \approx 80\text{dB}$ typ.
- Wide frequency response: $f_i \leq 12\text{KHz}$.
- Low distortion: $\text{THD} = 0.5\%$ typ. ($V_i = 0.78\text{Vrms}$).
- Clock frequency range: 10 ~ 100KHz.
- P channel silicon gate process.
- 8-Lead Dual-In-Line Plastic Package.

Applications

- Reverberation effect of echo microphone and stereo equipment.
- Chorus effect in electronic musical instrument.
- Variable or fixed delay of analog signals.
- Telephone time compression and delay line for voice communication systems, etc.

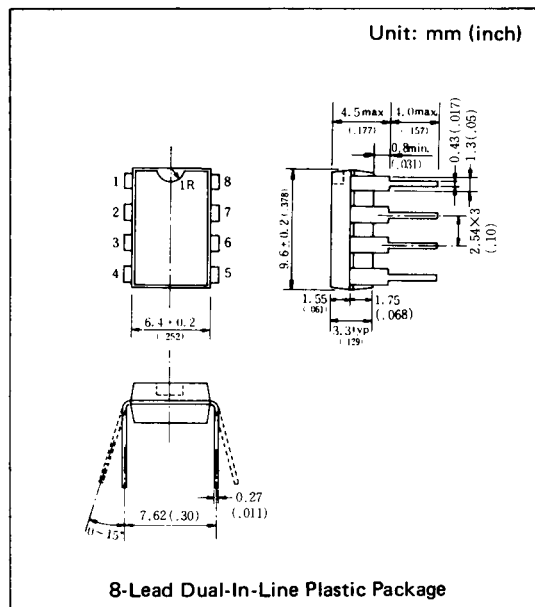

Block Diagram

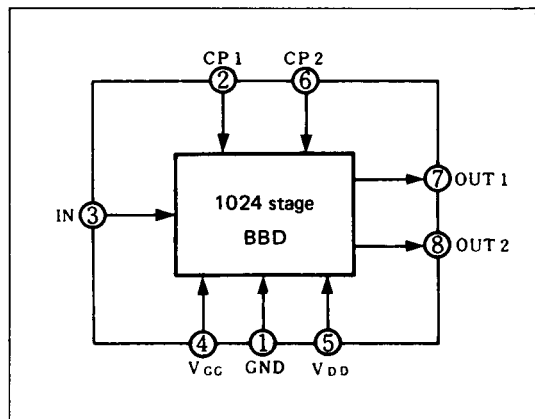

Quick Reference Data

Item	Symbol	Value	Unit
Supply Voltage	V_{DD}, V_{GG}	-15, $V_{DD} + 1$	V
Signal Delay Time	t_D	5.12~51.2	ms
Total Harmonic Distortion	THD	0.5	%
Signal to Noise Ratio	S/N	80	dB

■ Absolute Maximum Ratings (Ta = 25°C)

Item	Symbol	Ratings	Unit
Terminal Voltage	V _{DD} , V _{GG} , V _{CP} , V _I	-18~+0.3	V
Output Voltage	V _O	-18~+0.3	V
Operating Temperature	T _{opr}	-20~+60	°C
Storage Temperature	T _{stg}	-55~+125	°C

■ Operating Conditions (Ta = 25°C)

Item	Symbol	Condition	Min.	Typ.	Max.	Unit
Drain Supply Voltage	V _{DD}		-14	-15	-16	V
Gate Supply Voltage	V _{GG}			V _{DD} + 1		V
Clock Voltage "H" Level	V _{CPH}		0		-1	V
Clock Voltage "L" Level	V _{CPL}			V _{DD}		V
Clock Input Capacitance	C _{CP}				700	pF
Clock Frequency	f _{CP}		10		100	kHz
Clock Pulse Width *1	t _{cpw}				0.5T *2	
Clock Rise Time *1	t _{cpr}				500	ns
Clock Fall Time *1	t _{cpf}				500	ns
Clock Cross Point *1	V _X		0		-3	V
Input DC Bias	V _{Bias}		-5		-10	V

■ Electrical Characteristics (Ta = 25°C, V_{DD} = V_{CPL} = -15V, V_{CPH} = 0V, V_{GG} = -14V, R_L = 100kΩ)

Item	Symbol	Condition	Min.	Typ.	Max.	Unit
Signal Delay Time	t _D		5.12		51.2	ms
Input Signal Frequency	f _i	f _{CP} = 40kHz, V _i = 1.5Vrms, 3dB down (0dB at f _i = 1kHz)	12			kHz
Input Signal Swing	V _i	f _{CP} = 40kHz, f _i = 1 kHz, THD = 2.5%	1.5			Vrms
Insertion Loss	L _i	f _{CP} = 40kHz, f _i = 1 kHz, V _i = 1.5Vrms	-4	0	4	dB
Total Harmonic Distortion	THD	f _{CP} = 40kHz, f _i = 1 kHz, V _i = 0.78Vrms		0.5	2.5	%
Noise Voltage	V _{NO}	f _{CP} = 100kHz Weighted by "A" curve			0.3	mVrms
Signal to Noise Ratio	S/N			80		dB

*1 Clock Pulse Waveforms

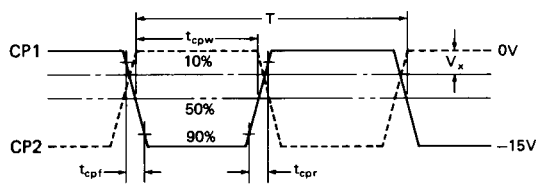

*2 T = 1/f_{CP} (Clock period)

■ Terminal Assignments

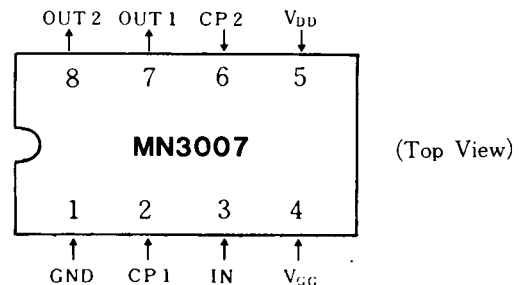

■ Circuit Diagram

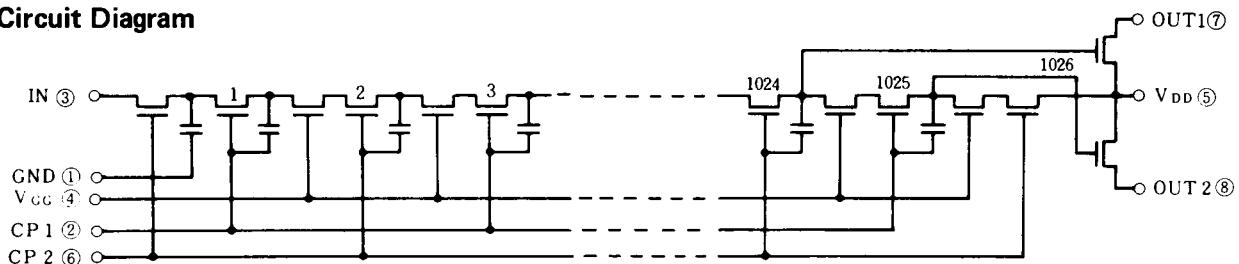

Typical Electrical Characteristic Curves

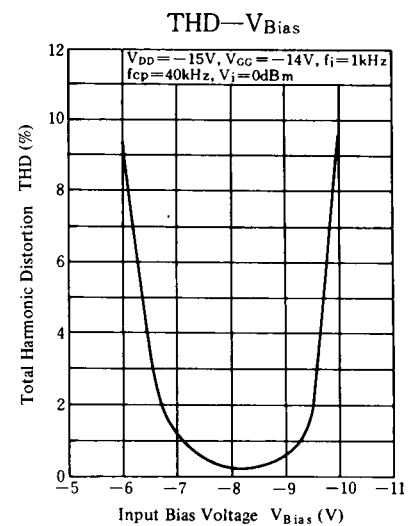
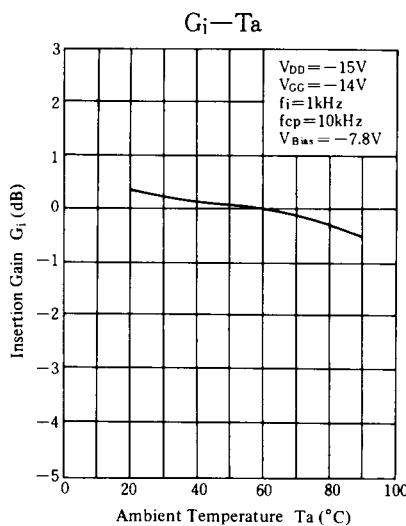
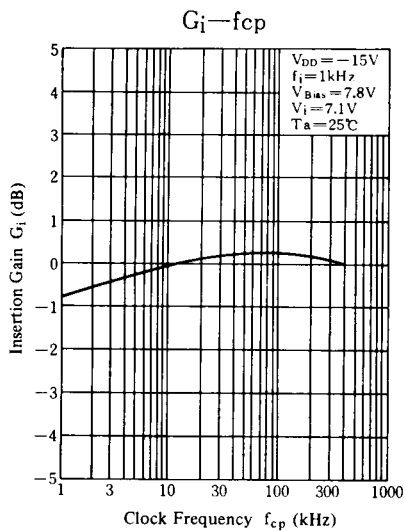
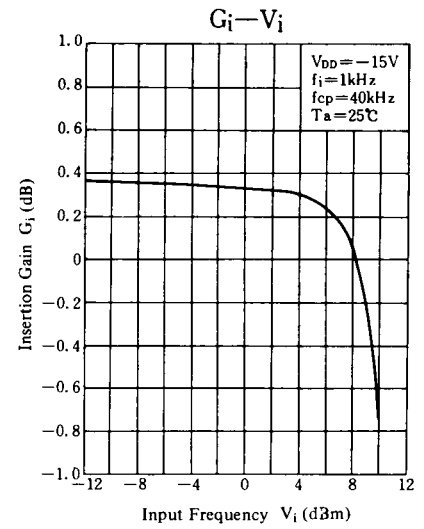
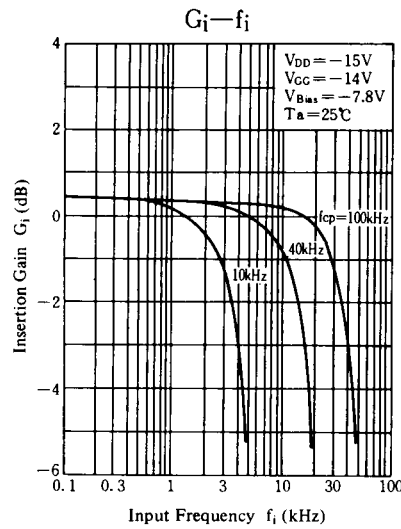
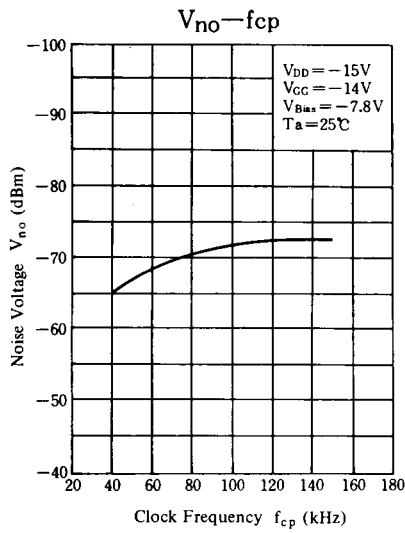
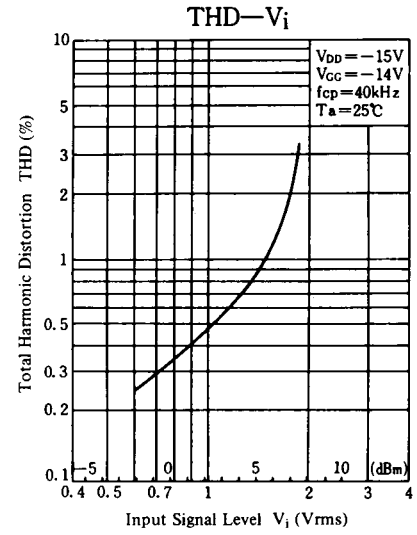
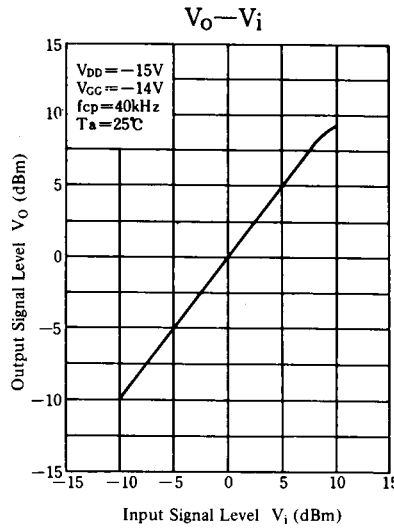
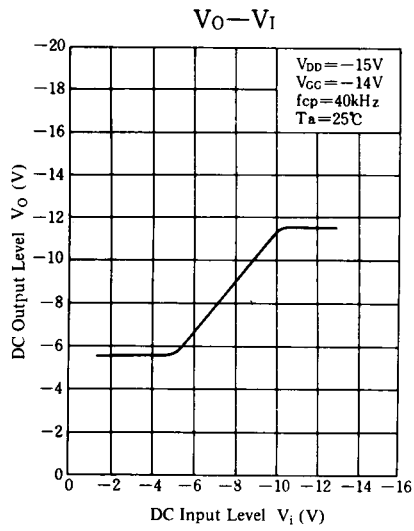

Supply Voltage Characteristics

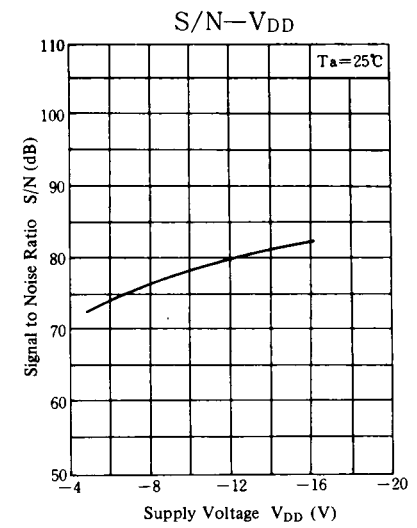
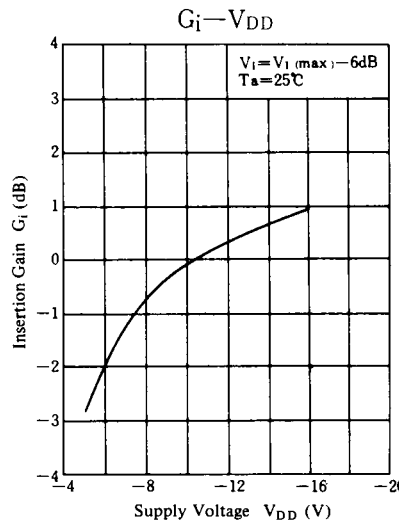
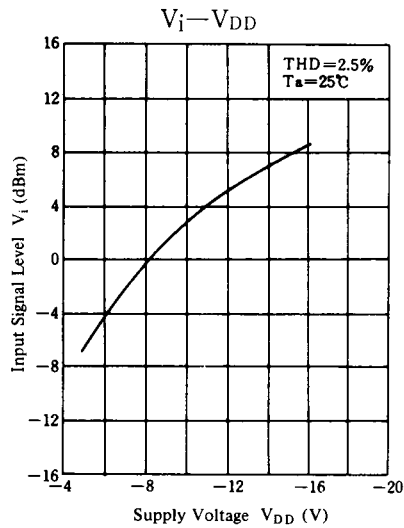
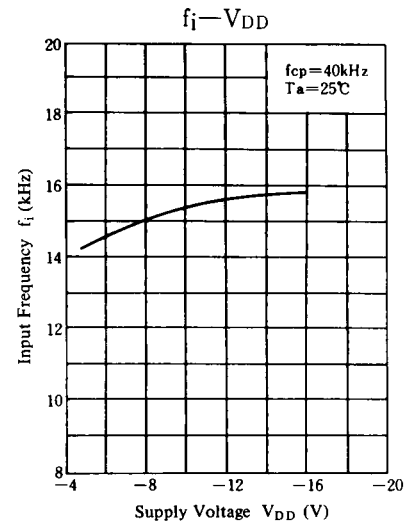
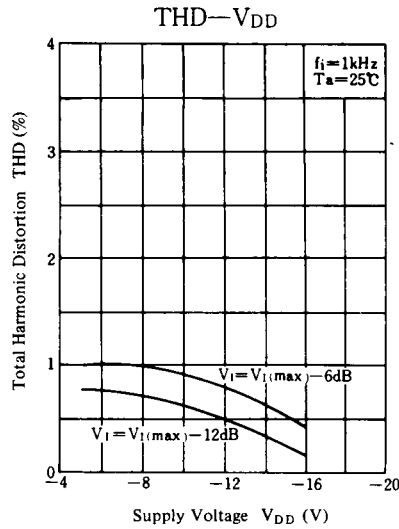
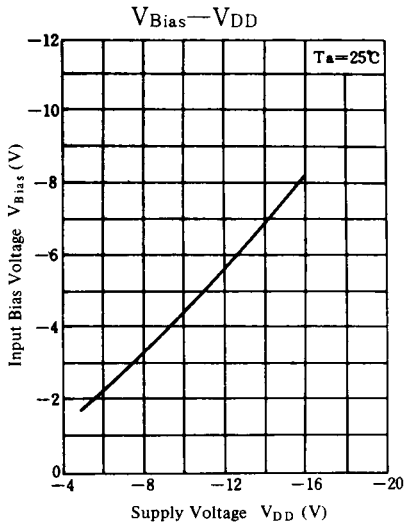

Application Circuit

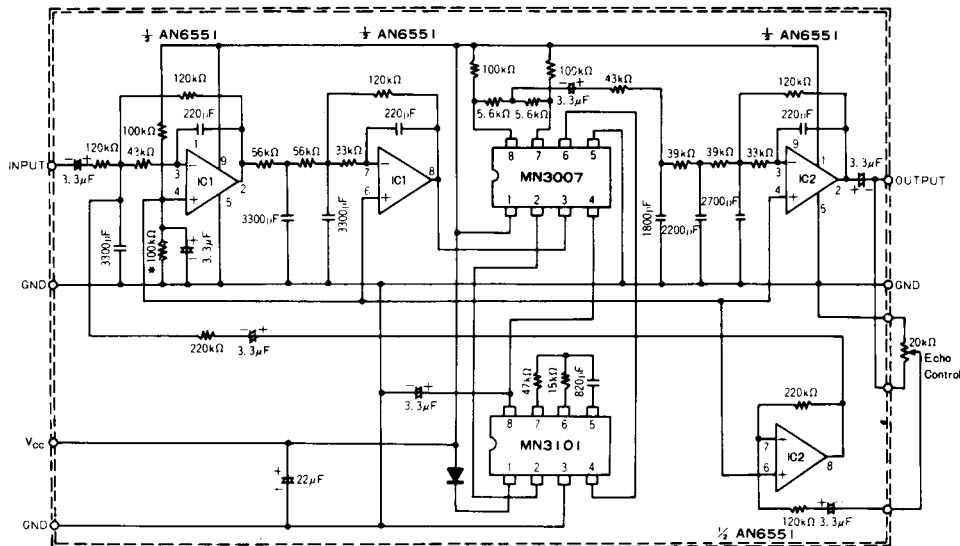

* Adjust to minimize distortion (VR 100kΩ typ.)

Echo Effect Generation Circuit (Signal Delay Over 10msec.)

This datasheet has been download from:

www.datasheetcatalog.com

Datasheets for electronics components.